

IL MANUALE
DEL BAGNO FUNZIONALE

THE FUNCTIONAL
BATHROOM MANUAL

—
24

X I L O N



I L

B A G N O

F U N Z I

O N A L E

INDICE

INDEX

Prefazione

Vedere il bagno con gli occhi di Xilon
Seeing the bathroom with Xilon's eyes

La storia di Xilon
The history of Xilon

Materiali
Materials

Personalizzare
Custom-made

04

Capitolo 1 Chapter 1 LINEA 46	17	Capitolo 2 Chapter 2 LINEA 48	37	Capitolo 3 Chapter 3 LINEA 26	53
1.1 La storia	17	1.1 La storia	37	1.1 La storia	53
1.2 La collezione	22	1.2 La collezione	40	1.2 La collezione	56
1.3 Area tecnica	32	1.3 Area tecnica	48	1.3 Area tecnica	64
1.4 Le nostre proposte	34	1.4 Le nostre proposte	50	1.4 Le nostre proposte	66
Capitolo 4 Chapter 4 LINEA 55	69	Capitolo 5 Chapter 5 LAUNDRY SHELF	97	Capitolo 6 Chapter 6 TOTUS	111
1.1 La storia	69	1.1 La storia	97	1.1 La storia	111
1.2 La collezione	72	1.2 La collezione	100	1.2 La collezione	114
1.3 Area tecnica	90	1.3 Area tecnica	106	1.3 Area tecnica	122
1.4 Le nostre proposte	92	1.4 Le nostre proposte	108	1.4 Le nostre proposte	124
Capitolo 7 Chapter 7 MENSOLONI	127				
1.1 La storia	127				
1.2 La collezione	130				
1.3 Area tecnica	140				
1.4 Le nostre proposte	142				
MONOBLOCCHI					
Capitolo 8 Chapter 8 ALLUMINIUM	149	Capitolo 9 Chapter 9 NANCO+	161	Capitolo 10 Chapter 10 GHOST	179
1.1 La storia	149	1.1 La storia	161	1.1 La storia	179
1.2 La collezione	152	1.2 La collezione	164	1.2 La collezione	182
1.3 Area tecnica	158	1.3 Area tecnica	174	1.3 Area tecnica	190
1.4 Le nostre proposte	159	1.4 Le nostre proposte	176	1.4 Le nostre proposte	192
Capitolo 11 Chapter 11 LAVARREDO	195	Capitolo 12 Chapter 12 SKEMA	213	Capitolo 13 Chapter 13 ICARO	223
1.1 La storia	195	1.1 La storia	213	1.1 La storia	223
1.2 La collezione	198	1.2 La collezione	216	1.2 La collezione	226
1.3 Area tecnica	208	1.3 Area tecnica	220	1.3 Area tecnica	232
1.4 Le nostre proposte	210	1.4 Le nostre proposte	221	1.4 Le nostre proposte	234

PREFAZIONE

VEDERE IL BAGNO CON GLI OCCHI DI XILON

SEEING THE BATHROOM WITH XILON'S EYES

IT

Questo non è solo il catalogo in cui conoscere tutti i nostri prodotti, ma è il manuale del bagno funzionale. Vi aiuterà a ripensare il bagno in base alle vostre esigenze quotidiane. Da quando esistiamo abbiamo evoluto il concetto di lavanderia per portarlo nel bagno di design. Il bagno funzionale è la nostra risposta. Agevola l'uso ed è adatto a ogni situazione, spazio e necessità.

Il bagno Xilon fa cose che un altro bagno non può fare. Offriamo un'ampia scelta di lavabi realizzati in ceramica italiana, oppure in ocritech, progettati da noi per essere versatili, con profondità e ampiezze uniche. Lavabi da applicare su mobili con 11 finiture legno, 2 essenze 4.0 e 46 tonalità di laccati. Infine, aggiungiamo complementi d'arredo utili e sorprendenti: pensili, mensole, specchi luminosi e contenitori da abbinare. Il bagno funzionale si adatta e ripensa gli spazi, qualità espressa al massimo anche nelle versioni di mobili e specchi su misura. Incontrare Xilon cambia il modo di vedere il bagno, da quello più piccolo a quello più grande. Dal lavabo da esterni al bagno di servizio. Dai bagni dei ristoranti a quelli degli studi medici. È intelligente e pratico. Vedere il bagno con gli occhi di Xilon significa invertire le proprie credenze. Un bagno innanzitutto pratico, poi bello. Perché crediamo che il bagno sia uno spazio da vivere, dove il design non deve limitare la funzionalità.

Funzionale, bello e sorprendente. Il bagno che amerai usare.

ENG

This is not only the catalogue in which to learn about all our products, but it's the guide to the functional bathroom. It will help you rethink the bathroom according to your daily needs. Throughout our existence we have evolved the concept of laundry to bring it into the designer bathroom. The functional bathroom is our answer. It facilitates use and is suitable for any situation, space and need. Xilon bathroom allows you to do things that another bathroom can't do. We offer a wide choice of washbasins made of Italian ceramic, or ocritech, designed by us to be versatile, with unique depths and widths. Washbasins to be applied on furniture with 11 wood finishes, 2 essenze 4.0 and 46 shades of lacquers. Lastly, we add useful and surprising furnishing accessories: wall units, shelves, lighted mirrors and containers to match. The functional bathroom adapts and rethinks spaces, quality expressed to the maximum even in the versions of custom-made furniture and mirrors. Meeting Xilon changes the way you see the bathroom, from the smallest to the largest one. From the outdoor basin to the service bathroom. From restaurant toilets to medical practice toilets. It's smart and practical. Seeing the bathroom with Xilon's eyes means reversing one's beliefs. A bathroom first of all practical, then beautiful. Because we believe that the bathroom is a space to be lived in, where where design must not limit functionality. Functional, beautiful and surprising. The bathroom you will love to use.



PREFAZIONE

**LA STORIA DI XILON,
dalla lavanderia
al bagno funzionale**

**THE HISTORY OF XILON,
from the laundry
to the functional bathroom**

IT

Ma come siamo arrivati a questa visione?

Xilon nasce dall'esperienza e dalla passione profuse da Giuseppe Colamedici nel settore dell'ebanisteria già in giovane età, quando come garzone di bottega imparò a Civita Castellana il mestiere del falegname. Nel 1956 emigra in Venezuela, Caracas, con la propria moglie e intraprende un'attività di produzione mobili. Matura competenze nella lavorazione in serie e raggiunge un buon successo. È alla soglia dei 70 anni quando, insieme a Franco Fulvio, il figlio più piccolo, si mette nuovamente in discussione.

Fonda Xilon a Civita Castellana, importante polo ceramico di sanitari nella provincia di Viterbo, e inizia una nuova esperienza nel mercato dei mobili per l'arredamento da bagno.

La visione era chiara: lanciare l'idea del "bagno funzionale". Abbiamo ripensato l'esperienza contenitiva della lavanderia per portarla verso l'arredo bagno, da lavatoio a bagno funzionale. Con la realizzazione di nuovi lavabi in ceramica, abbiamo cercato di reinterpretare l'approccio al mercato. Siamo stati dei pionieri: lavabi in ceramica che non potevi trovare da nessun'altra parte.

Da qui inizia un percorso di innovazione e di continua ricerca di idee e soluzioni, che ci ha reso quello che siamo: una realtà volta ad ascoltare le vostre esigenze che propone alternative per arredare il bagno.

ENG

But how did we arrive at this vision?

Xilon is born from the experience and passion devoted by Giuseppe Colamedici to the field of cabinet-making already at a young age, when as a shop boy he learned the carpenter's trade in Civita Castellana. In 1956 he emigrates to Venezuela, Caracas, with his wife and starts a furniture production business. He accrues expertise in mass production and achieves good success. He is at the age of nearly 70 when, together with Franco Fulvio, his youngest son, he challenges himself again. He founds Xilon in Civita Castellana, an important ceramic hub of sanitaryware in the province of Viterbo, and begins a new experience in the bathroom furniture market.

The vision was clear: to launch the idea of the "functional bathroom". We have rethought the storage experience of the laundry room to bring it towards bathroom furnishings, from a washroom to a functional bathroom. With the creation of new ceramic washbasins, we tried to reinterpret the approach to the market. We were pioneers: ceramic sinks you couldn't find anywhere else. From here begins a path of innovation and continuous search for ideas and solutions, which has made us what we are: a reality aimed at listening to your needs, that offers alternatives for furnishing the bathroom.



1956

Venezuela

1959

"Gran Sasso" Carpentry Foundation

1997

Xilon is born

1998

First CERSAIE participation in Bologna

2002

Lavarredo® is born

2009

Nanco® is born

2012

Block is born

2016

First participation in the "Salone Internazionale del Mobile" in Milan

2019

Ghost® is born

2020

Ghost® wins the German Design Awards

2023

Basinbbasket® is born

20...

The story continues

1956

Venezuela

1959

Fondazione Falegnameria "Gran Sasso"

1997

Nasce Xilon

1998

Prima partecipazione CERSAIE di Bologna

2002

Nasce Lavarredo®

2009

Nasce Nanco®

2012

Nasce Block

2016

Prima partecipazione al "Salone Internazionale del Mobile" di Milano

2019

Nasce Ghost®

2020

Ghost® vince il German Design Awards

2023

Nasce Basinbbasket®

20...

La storia continua

I MATERIALI

MATERIALS

IT

Di cosa sono fatti i mobili Xilon? Sono fatti con materiali selezionati da filiera italiana. Materiali spesso riciclati o riciclabili, perché ridurre l'impatto sull'ambiente per noi è importante. Ogni nostro mobile è solido, duraturo ed ecologico. Vi farà compagnia per i prossimi anni.

ENG

What is Xilon furniture made of? They are made with materials selected from the Italian supply chain. Materials often recycled or recyclable, because reducing the impact on the environment is important to us. Each of our pieces of furniture is solid, long-lasting and ecological. It will keep you company for the next few years.



Ceramica

Ceramic

IT

Ogni lavabo in ceramica Xilon è un autentico capolavoro italiano. Siamo a Civita Castellana (Viterbo), cittadina protagonista da molti secoli nella produzione di articoli in ceramica, oggi polo industriale della ceramica sanitaria. Qui sono le nostre radici: nella ceramica. Un materiale che richiede maestria e perizia per essere plasmato e trasformato in un prodotto eccelso. La ceramica, materia versatile e perfetta per l'uso domestico, è resistente e facile da igienizzare.

I lavabi in ceramica Xilon sono disponibili in 4 tonalità di colore: Bianco lucido, Bianco matt, Nero matt e Sabbia.

ENG

Each Xilon ceramic washbasin is an authentic Italian masterpiece. We are in Civita Castellana (Viterbo), a town that has been a protagonist for many centuries in the production of ceramic items, today an industrial hub for sanitaryware ceramics. Here are our roots: in ceramics. A material that requires mastery and expertise to be shaped and transformed into an excellent product. Ceramic, a versatile and perfect material for domestic use, resistant and easy to sanitize.

Xilon ceramic washbasins are available in 4 color shades: Glossy White, Matt White, Matt Black and Sand.

Ocritech

IT

L'ocritech è un materiale straordinario, elegante e setoso al tatto. È un acrilico a tutta massa, simile a un solid surface, che permette di realizzare top e lavabi con precisione millimetrica. Oltre all'evidente resa estetica, è un materiale funzionale: resistente alle macchie, facile da pulire, ripristinabile dai graffi e non ingiallisce.

È un elemento di design, bello e al contempo durevole; realizzato con una produzione circolare da materiali riciclati e a sua volta riciclabile.

Disponibile in Bianco opaco e Bianco lucido.

ENG

Ocritech is an extraordinary material, elegant and silky to the touch. It is a full-body acrylic, similar to a solid surface, which allows you to create tops and sinks with millimetric precision. In addition to the obvious aesthetic effect, it is a functional material: resistant to stains, easy to clean, repairable from scratches and does not yellow. It is a design element, beautiful and at the same time durable; made with circular production from recycled materials and in turn recyclable.

Available in matt white and glossy white.





Pannello nobilitato

Melamine panel

IT

Questo materiale contribuisce a rendere il bagno Xilon ancora più ecologico. I pannelli in nobilitato utilizzati per costruire i nostri mobili nascono dagli scarti di lavorazione del legno e dal recupero di oggetti di arredo in disuso. Fa parte quindi di una filiera ecosostenibile che mira al recupero e alla riduzione degli sprechi attraverso un sistema circolare. È riciclabile, leggero e versatile, lo scheletro ecologico delle nostre produzioni.

ENG

This material contributes to making the Xilon bathroom even more eco-friendly. The melamine panels used to build our furniture are born from wood processing waste and from the recovery of disused furnishing objects. It is therefore part of an eco-sustainable supply chain that aims to recover and reduce waste through a circular system. It's recyclable, light and versatile, the ecological skeleton of our productions.

Alluminio

Aluminum

IT

L'alluminio è un materiale che caratterizza alcune delle nostre collezioni. È speciale perché tecnicamente performante e dà un tono urban chic all'arredamento. Anche l'alluminio è riciclabile, dunque ecologico ed etico, eppure è resistente agli agenti più aggressivi. La collezione Alluminium ne è un esempio: il monoblocco è realizzato con lastre di alluminio riciclato che corrispondono a 923 lattine da 33 cl. Questo materiale ci permette di offrire mobili dall'estetica raffinata e contemporanea, nei colori Nero, Gold, Bronzo e nelle finiture laccate RAL.

ENG

Aluminum is a material that characterizes some of our collections. It's special because it's technically high-performance and gives an urban chic tone to the furnishings. Gold, Bronzo e nelle finiture laccate RAL. Aluminum too is recyclable, therefore ecological and ethical, yet it is resistant to the most aggressive agents. The Alluminium collection is an example of this: the monobloc is made with recycled aluminum sheets which correspond to 923 cans of 33 cl. This material allows us to offer furniture with a refined and contemporary aesthetic, in Black, Gold, Bronze and RAL lacquered finishes.

Essenza 4.0®

IT

Essenza 4.0 è un materiale pregiato che avvolge i sensi e ci fa respirare il foliage di un bosco, anche nel nostro bagno. La superficie di questo pannello, certificato FSC, è realizzata da una impiallacciatura di pergamena vegetale che nasce con l'amalgama di materiali naturali, come ad esempio le foglie. Grazie alla nanotecnologia, il risultato è di un caldo effetto legno, piacevole al tatto, versatile nell'utilizzo ed estremamente gradevole alla vista. Unisce naturalezza, resistenza ed eleganza. Disponibile in Rovere moro e Olmo grigio.

ENG

Essenza 4.0 is a precious material that envelops the senses and makes us breathe the foliage of a wood, even in our bathroom. The surface of this panel, FSC certified, is realized from a vegetable parchment veneer that is born from the amalgamation of natural materials, such as leaves. Thanks to nanotechnology, the result is a warm wood effect, pleasant to the touch, versatile in use and extremely pleasing to the eye. It combines naturalness, resistance and elegance. Available in dark oak and gray elm.

LE FINITURE

FINISHES

IT

Arredate il vostro bagno con personalità, scegliete tra tanti laccati lucidi e opachi, applicati con laccatura ecologica a emissioni ridotte, e molti toni di legno. Inoltre, su richiesta potete dare un tocco di stile personalizzato con le finiture bicolore: legno+lucido, legno+opaco e opaco+lucido.

ENG

Decorate your bathroom with personality, choose from many glossy and matt lacquers, applied with eco-friendly low-emission lacquering, and many wood tones. Furthermore, upon request you can give a touch of personalized style with the two-tone finishes: wood+gloss, wood+mat and matt+gloss.

LACCATI

LACQUERS

IT

Con 46 tonalità disponibili, lucide e opache, la nostra gamma cromatica vi dà ampie possibilità creative. Inoltre, possiamo realizzare un colore RAL personalizzato, un'ulteriore punta di personalità al bagno desiderato. La laccatura dei mobili Xilon con metodo di verniciatura all'azoto riduce drasticamente l'overspray e abbatta l'emissione in atmosfera, per una laccatura ecologica.

ENG

With 46 shades available, both glossy and matt, our color range gives you extensive creative possibilities. Furthermore, we can create a customized RAL colour, a further touch of personality to the desired bathroom. The lacquering of Xilon furniture with the nitrogen painting method drastically reduces overspray and cuts emissions into the atmosphere, for an ecological lacquering.



LEGNO

WOOD

IT

In catalogo abbiamo 11 finiture in legno per un mobile distinto e con personalità. Un effetto di design naturale e intenso che caratterizzerà il vostro bagno. Per tutelare l'ambiente, i pannelli in melaminico usati da noi provengono dalla filiera ecologica, l'obiettivo è sempre ridurre l'impatto delle nostre produzioni.

ENG

In the catalog we have 11 wooden finishes for a piece of furniture distinguished and with personality. A natural and intense design effect that will characterize your bathroom. To protect the environment, the melamine panels used by us come from the ecological supply chain, the aim is always to reduce the impact of our products.

CALÀN

IT

Intrigante alla vista, sinuosa al tatto. Calàn è la nuova finitura tridimensionale di Xilon. Questa superficie ondulata si veste di luci e ombre, il risultato è un effetto di profondità ed eleganza che attira l'occhio e accende il desiderio di contatto. Disponibile nella finitura in legno noce e nei colori laccati opachi.

ENG

Intriguing to the eye, sinuous to the touch. Calàn is the new three-dimensional finish from Xilon. This wavy surface is dressed in lights and shadows, the result is an effect of depth and elegance that attracts the eye and ignites the desire for contact. Available in walnut wood finish and in matt lacquered colours.

PERSONALIZZARE: Funzionalità su misura

CUSTOM-MADE: Tailored Functionality

IT

In una casa ottimizzare gli spazi è fondamentale, per questo offriamo anche il servizio di personalizzazione. Perché un bagno su misura accresce la funzionalità. Le basi e i pensili a giorno sono allungabili da 15 a 35 cm, senza variazioni di prezzo. E possiamo ridimensionare anche gli specchi a misura.

Personalizzazione non solo funzionale, ma anche estetica. Completiamo i mobili con combinazioni di colori e finiture realizzate solo per voi. Il risultato è un mobile con personalità disegnato sulla scia dei vostri desideri.

ENG

In a home, optimizing spaces is essential, which is why we also offer the customization service. Because a custom-made bathroom increases functionality. The open bases and wall units can be extended from 15 to 35 cm, without price changes. And we can resize the mirrors to size too. Not only functional but also aesthetic customization. We complete the furniture with color combinations and finishes realized just for you. The result is a piece of furniture with personality designed in the wake of your desires.



BASINBASKET®

IT

Basinbasket rivoluziona il concetto di lavabo, ampliandone il suo uso. Il lavabo Dual Level si veste di una funzione nuova, al piano estraibile del lavello, che lo divide generando due profondità di vasca, vengono aggiunti dei contenitori; rendendolo il primo lavabo contenitore presente sul mercato. Una soluzione che sfrutta uno spazio inutilizzato e permette di riporre oggetti umidi, come spugne e pezzette, che si asciugheranno senza generare muffe grazie al naturale ricircolo dell'aria.

ENG

Basinbasket removable the concept of the washbasin, broadening its use. The Dual Level washbasin dresses in a new function: containers are added to the extractable top of the sink, which divides it creating two basin depths, making it the first container washbasin on the market. A solution that takes advantage of unused space and allows you to store damp objects, such as sponges and rags, which will dry without generating mold thanks to the natural recirculation of air.

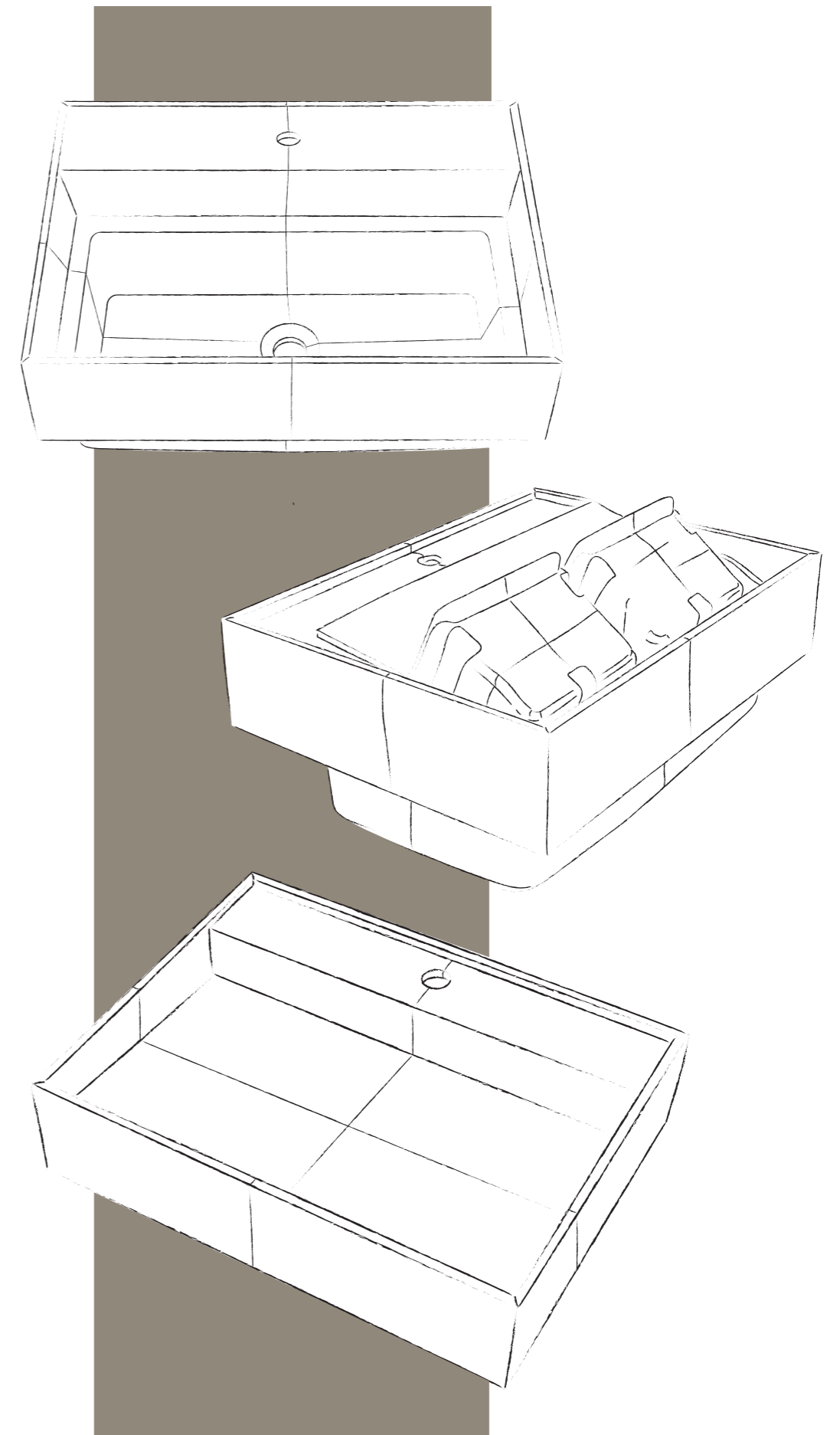
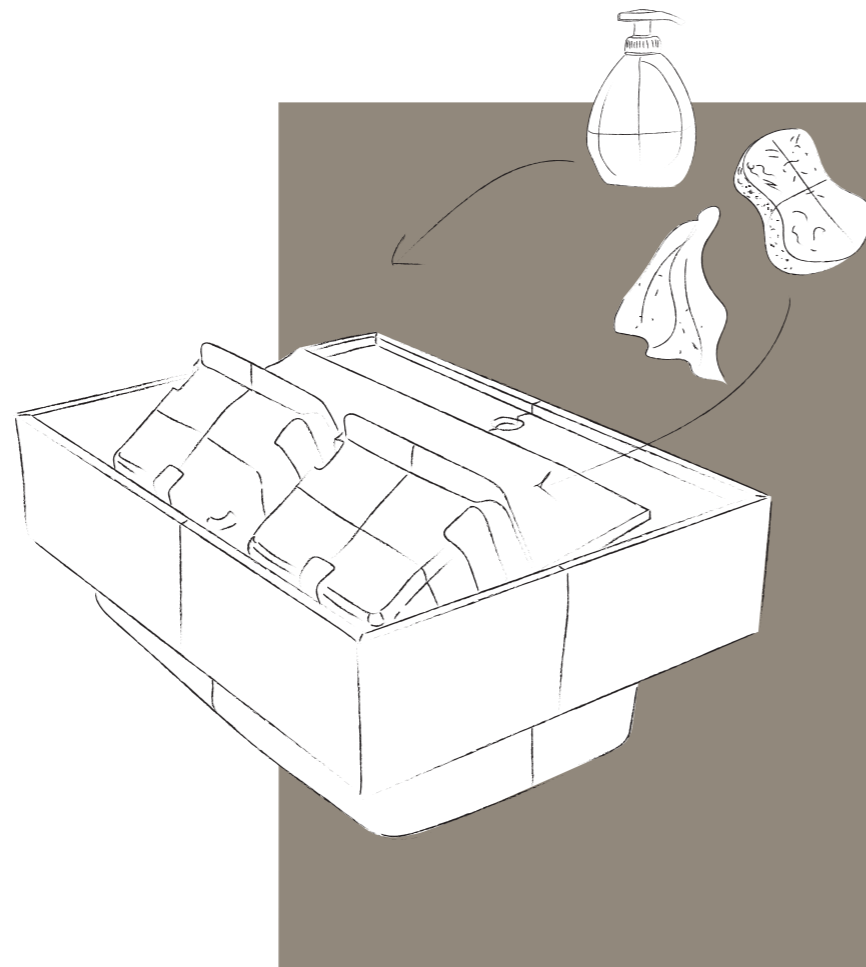



LINEA 46

—
4,5 m² 1:50

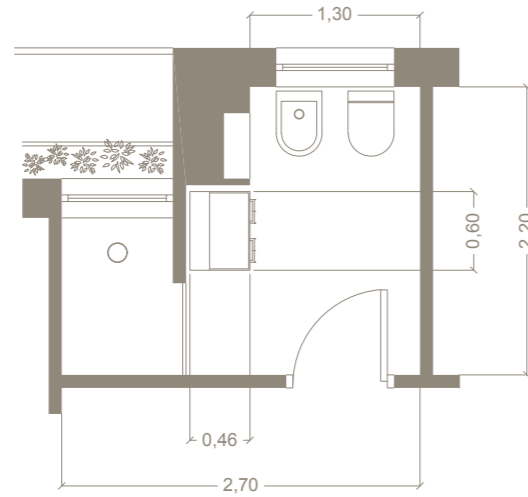

IT

L'ultima meraviglia di Xilon: la Linea 46. Con questa nuova profondità uniamo armoniosamente il mobile da bagno, sospeso o a terra, con gli innovativi lavabi in ocritech, tra cui il Basinbbasket.

Il Basinbbasket rappresenta l'apoteosi del design funzionale. Questo lavabo nasconde un segreto che cattura l'occhio al primo sguardo. È un bellissimo lavabo di design che nasconde un doppio fondo contenitore; infatti il piano svela delle tasche sul lato inferiore, perfette per contenere spugne, detersivi e tutto ciò che può rendere il tuo bagno organizzato. È un sistema patent pending ideato da noi: il Basinbbasket®.

Eleganza e funzionalità si uniscono in un'esperienza senza precedenti. Non è un bagno convenzionale, Linea 46 è il bagno che non ti aspetti.

ENG

Xilon's latest wonder: Linea 46. With this new depth we harmoniously merge the bathroom cabinet, suspended or floor-standing, with the innovative ocritech washbasins, including the Basinbbasket.

The Basinbbasket represents the apotheosis of functional design. This washbasin hides a secret that catches the eye at first glance: It's a beautiful designer washbasin that hides a double bottom container; indeed the top reveals pockets on the lower side, perfect for holding sponges, detergents and everything that can make your bathroom organized. It's a patent pending system designed by us: the Basinbbasket®.

Elegance and functionality come together in an unprecedented experience. It's not a conventional bathroom, Linea 46 is the bathroom you don't expect.



2
Composizione
Composition

LINEA 46

3
Composizione
Composition

LINEA 46





4

Composizione
Composition

LINEA 46



5

Composizione
Composition

LINEA 46



6
Composizione
Composition

LINEA 46

7
Composizione
Composition

LINEA 46



8
Composizione
Composition

LINEA 46





COLORI DISPONIBILI

COLORS AVAILABLE

TUNDRA Opaco Matt Lucido Glossy cod. 01TN cod. 02TN	CAPPUCCINO Opaco Matt Lucido Glossy cod. 01CU cod. 02CU	BIANCO Opaco Matt Lucido Glossy cod. 01BO cod. 02BO
ROSA HIMALAYA Opaco Matt Lucido Glossy cod. 01RH cod. 02RH	CORDA Opaco Matt Lucido Glossy cod. 01CD cod. 02CD	SALVIA Opaco Matt Lucido Glossy cod. 01SV cod. 02SV
BALTICO Opaco Matt Lucido Glossy cod. 01BT cod. 02BT	BURRO Opaco Matt Lucido Glossy cod. 01BR cod. 02BR	VERDE Opaco Matt Lucido Glossy cod. 01VE cod. 02VE
PRUGNA Opaco Matt Lucido Glossy cod. 01PR cod. 02PR	MENTA Opaco Matt Lucido Glossy cod. 01MN cod. 02MN	ZUCCA Opaco Matt Lucido Glossy cod. 01ZC cod. 02ZC
CIOCCOLATO Opaco Matt Lucido Glossy cod. 01CT cod. 02CT	SENAPE Opaco Matt Lucido Glossy cod. 01SN cod. 02SN	TURCHESE Opaco Matt Lucido Glossy cod. 01TR cod. 02TR
GRIGIO Opaco Matt Lucido Glossy cod. 01GR cod. 02GR	SABBIA Opaco Matt Lucido Glossy cod. 01SB cod. 02SB	
NERO Opaco Matt Lucido Glossy cod. 01NR cod. 02NR	ARANCIO Opaco Matt Lucido Glossy cod. 01AA cod. 02AA	
PIETRA Opaco Matt Lucido Glossy cod. 01PE cod. 02PE	CANAPA Opaco Matt Lucido Glossy cod. 01CN cod. 02CN	
AVIO Opaco Matt Lucido Glossy cod. 01AV cod. 02AV	ARGILLA Opaco Matt Lucido Glossy cod. 01FN cod. 02FN	

IT

46 cm. La profondità ideale per i bagni con spazi ridotti, ma che hanno bisogno di praticità, funzionalità, design e idee sorprendenti.

ENG

46 cm. The ideal depth for bathrooms with limited space, but which need practicality. Amazing functionality, design and ideas.

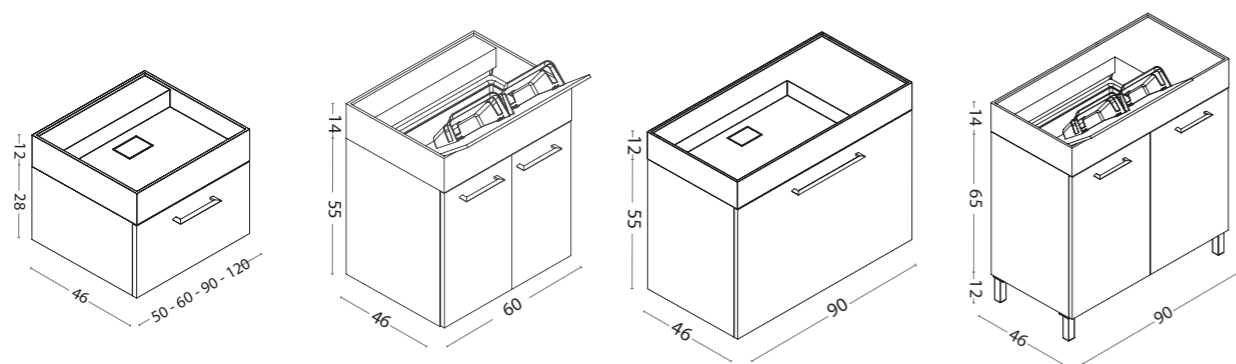

IT

Il Basinbbasket è un'evoluzione del Dual Level. Il lato inferiore del fondo rimovibile, solitamente vuoto per la funzione di lavanderia, dispone di due pratiche tasche nelle quali inserire tutti gli oggetti utili per il bagno.

ENG

The Basinbbasket is an evolution of the Dual Level. The lower side of the removable bottom, usually empty for the laundry function, features two practical pockets in which to insert all useful items for the bathroom.

LEGGI MELAMINICI MELAMINE WOODS

BIANCO VERTICAL cod. VT	LARICE IRIS cod. IL
BASIC WHITE cod. BW	OLMO MONTANO cod. MO
ROVERE ADAMELLO cod. AR	OLMO PERLA cod. PO
QUERCIA BRUCIATO cod. BT	QUERCIA BIANCO cod. QB
ROVERE ROSA cod. RR	ANTRACITE cod. AN
CEMENTO cod. CT	
ESSENZA 4.0	
ROVERE MORO cod. MR	OLMO GRIGIO cod. GO

IT

L'ocritech è un materiale con cui otteniamo lavabi e superfici precisi al millimetro.

ENG

Ocritech is a material with which we obtain washbasins and surfaces accurate to the millimeter.

IT

Il design del Dual Level è minimale e sofisticato. Quando è chiuso, l'acqua scorre in una sottile fessura. Il piano si rimuove con una leggera pressione, diventando più alto e capiente.

ENG

The design of the Dual Level is minimal and sophisticated. When closed, water flows through a thin slit. The top can be removed with a slight pressure, becoming taller and more capacious.



LE NOSTRE PROPOSTE

OUR PROPOSALS

LINEA 46 - 1

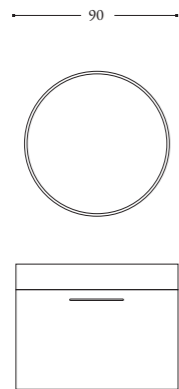

- IT **46DLC905SX** Monoblocco sospeso con cassettone L90xP46xH69 con lavabo in ocritech Basinb Basket. Bacino sx - **1213RSD** Specchio tondo a giorno Ø80 con sabbiatura perimetrale retroilluminata, touch e dimmer integrato.
- ENG **46DLC905SX** Suspended monobloc with drawer W90xD46xH69 with Basinb Basket ocritech washbasin. Left basin. - **1213RSD** Round open mirror Ø80 with backlit perimeter sandblasting, touch and integrated dimmer

LINEA 46 - 2

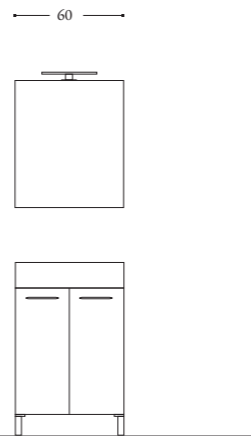

- IT **46DL607** Monoblocco a terra con piedini L60xP46xH96 con lavabo in ocritech Basinb Basket. - **229S61** Specchio pensile contenitore L58xP15xH70 - 737 Lampada mod. Diamond L45cm
- ENG **46DL607** Floor-standing monobloc with W60xD46xH96 feet with Basinb Basket ocritech washbasin. - **229S61** Hanging container mirror W58xD15xH70 - 737 Lamp mod. Diamond L45cm

LINEA 46 - 7



- IT **1350RSD** Specchio a giorno L50xH70 con sabbiatura perimetrale retroilluminata, touch e dimmer integrato - **46C505** Monoblocco sospeso 1 anta L50xP46xH67 con lavabo in Ceramica bacino centrale
- ENG **46C505** Suspended monobloc 1 door W50xD46xH67 with ceramic washbasin central basin - **1350RSD** Open mirror W50xH70 with backlit perimeter sandblasting, touch and integrated dimmer

LINEA 46 - 8

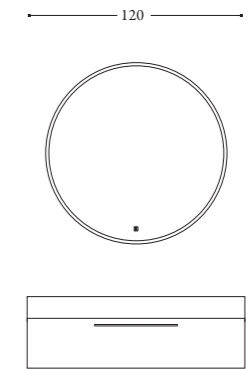

- IT **46CC1202** Monoblocco sospeso 1 cassetto L120xP46xH40 con lavabo in ceramica bacino centrale - **1215RSD** Specchio Ø 100 con sabbiatura perimetrale, touch e dimmer integrato
- ENG **46CC1202** Suspended monobloc 1 drawer W120xD46xH40 with ceramic washbasin central basin - **1215RSD** Ø 100 mirror with perimeter sandblasting, touch and integrated dimmer

LINEA 46 - 3

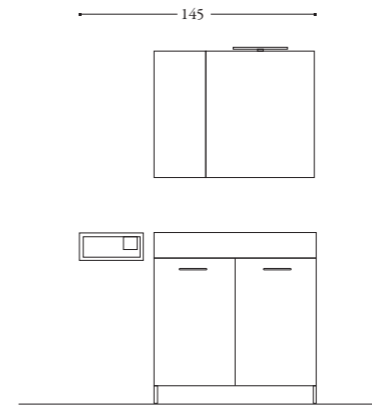

- IT **46DL907DX** Monoblocco a terra con piedini L90xP46xH96 con lavabo in ocritech Basinb Basket. Bacino dx - **22922** Pensile contenitore 1 anta L29xP22xH70 - **1360** Specchio a giorno Easy L60xH70 - **718** Lampada mod. Luna 30 nera - **3MLOTB35** Mensola multifunzione L35xP15xH15 con ripiano e bicchiere integrato in ocritech
- ENG **46DL907DX** Floor standing monobloc with feet W90xD46xH96 with Basinb Basket ocritech washbasin. Right basin - **22922** Wall unit 1 door W29xD22xH70 - **1360** Easy open mirror W60xH70 - **718** Lamp mod. Luna 30 black - **3MLOTB35** Multifunctional shelving unit W35xD15xH15 with shelf and integrated glass in ocritech

LINEA 46 - 4

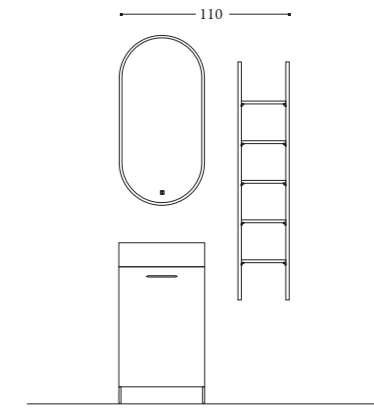

- IT **46DL507** Monoblocco a terra con piedini L60xP46xH96 con lavabo in ocritech Basinb Basket. - **1216RSD** Specchio ovale L50xH100 con sabbiatura perimetrale retroilluminata, touch e dimmer integrato - **3RUV30140** Pensile a giorno in alluminio L30xH140 con ripiani in vetro fumè nera
- ENG **46DL507** Floor-standing monobloc with feet W60xD46xH96 with Basinb Basket ocritech washbasin. - **1216RSD** Oval mirror W50xH100 with backlit perimeter sandblasting, touch and integrated dimmer - **3RUV30140** Open wall unit in aluminum W30xH140 with smoked glass shelves black

LINEA 46 - 5

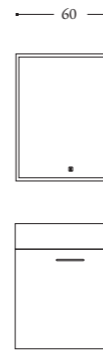

- IT **46DLC605** Monoblocco sospeso c/cassettone L60xP46xH69 con lavabo in ocritech Basinb Basket - **1360RSD** Specchio a giorno L60xH70 con sabbiatura perimetrale retroilluminata, touch e dimmer integrato
- ENG **46DLC605** Suspended monobloc w/drawer W60xD46xH69 with Basinb Basket ocritech washbasin - **1360RSD** Open mirror W60xH70 with backlit perimeter sandblasting, touch and integrated dimmer

LINEA 46 - 6

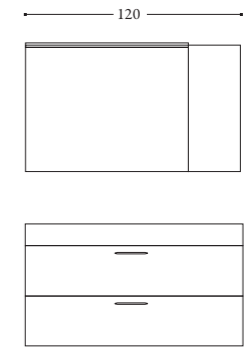

- IT **46L2C1205SX** Monoblocco sospeso con due cassetti L120xP46xH69 con lavabo in ocritech. Bacino sx. - **3RM9070** Specchiera Road con mensola integrata L90xH70 Bronzo - 733 Lampada mod. Mirror L90 nera - **22922** Pensile contenitore 1 anta L29xP22xH70a
- ENG **46L2C1205SX** Suspended monobloc with two drawers W120xD46xH69 with ocritech sink. Left washbasin. - **3RM9070** Road mirror with integrated shelf W90xH70 Bronze - 733 Lamp mod. Mirror L90 black - **22922** Wall unit 1 door W29xD22xH70

LINEA 48

IT

Il panno scorre veloce e senza ostacoli lungo la superficie del lavandino. Da quando Alessio è andato a vivere da solo ha dovuto cambiare tutte le sue abitudini, tra cui l'igiene della casa e quella del bagno. Quel materiale, l'ocritech, si pulisce divinamente. Può farlo in qualsiasi momento: apre gli ampi cassettoni del mobile, prende il necessario, e via di spugna. Una volta compiuto, può ammirare il suo lavoro, il resto lo fa la bellezza del mobilio.

ENG

The cloth slides quickly and unhindered along the surface of the sink. Since Alessio went to live alone he has had to change all his habits, including home and bathroom hygiene. That material, ocritech, cleans divinely. He can do it at any time: he opens the large drawers of the cabinet, takes what he needs, and go with the sponge. Once completed, he can admire his work, the rest is done by the beauty of the furniture.

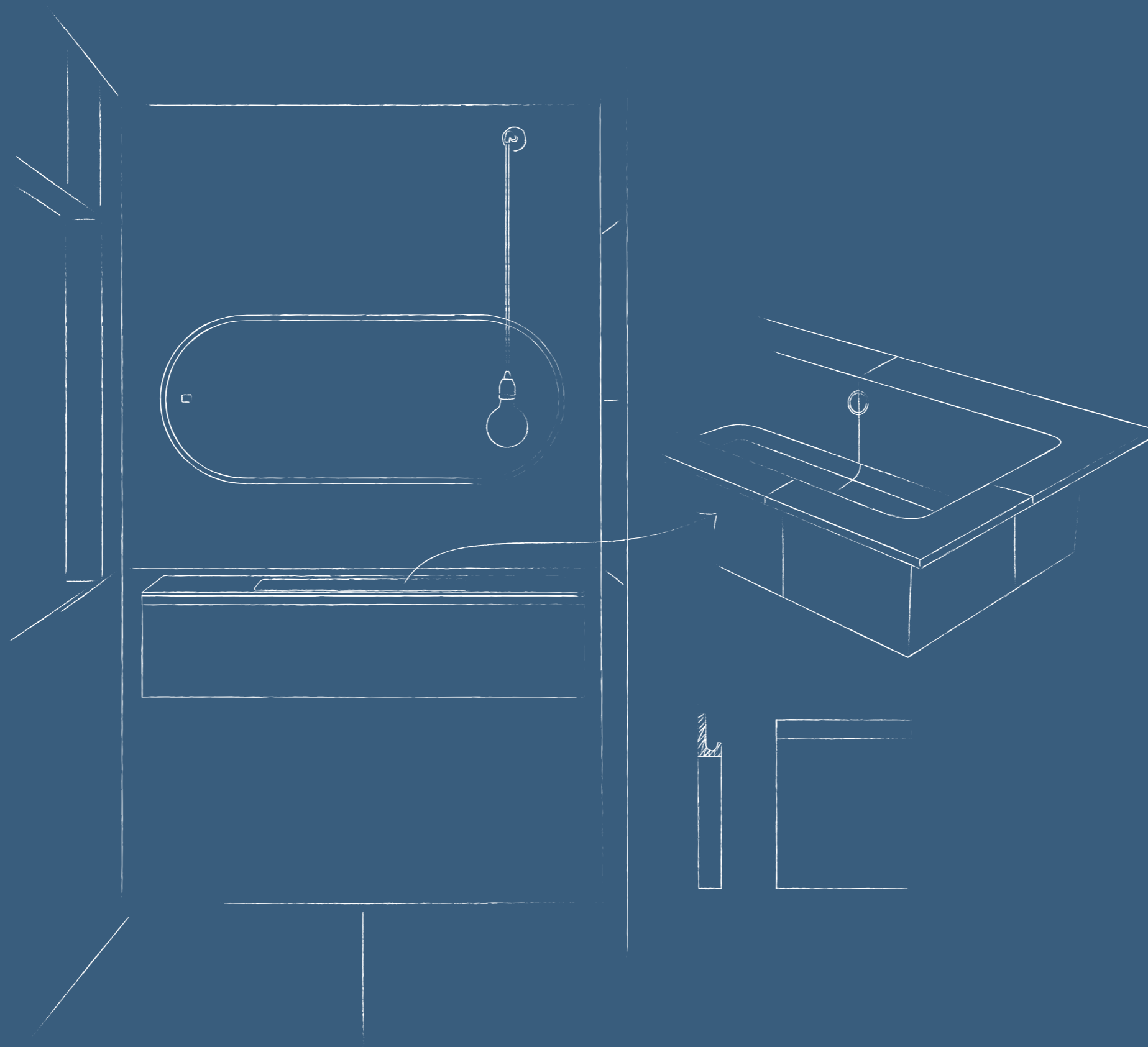

1

Composizione
Composition

LINEA 48

LINEA 48

5 m² 1:50

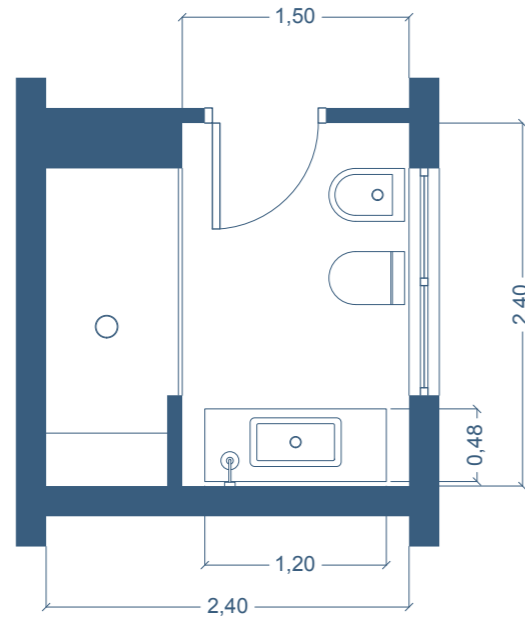

IT

Linea 48 è un'ode alla bellezza e alla funzionalità. Un bagno di design destinato a trasformare il vostro spazio in un'oasi di serenità e stile. Immaginatevi immergere le mani in un lavabo avvolto in un'aura di eleganza. La scelta è vostra: il lavabo in ocritech, un materiale che coniuga resistenza, precisione e raffinatezza, su un piano spesso solo 1 cm, o l'inesauribile bellezza della ceramica. Che sia a incasso, per un look minimalista e un bacino profondo, o sopra piano, per un tocco di raffinata audacia, la Linea 48 catturerà l'attenzione di ogni ospite.

Qui versatilità è la parola d'ordine. Componibile nei mobili e nei complementi d'arredo. È dotato di cassettoni spaziosi con eleganti maniglie a gola. Scegliete tra un'ampia gamma di finiture e colori ed esprimete il vostro stile.

ENG

Linea 48 is an ode to beauty and functionality. A designer bathroom destined to transform your space into an oasis of serenity and style. Imagine immersing your hands in a washbasin wrapped in an aura of elegance. The choice is yours: the washbasin in ocritech, a material that combines resistance, precision and refinement, on a top only 1 cm thick, or the inexhaustible beauty of ceramic. Whether recessed, for a minimalist look and a deep basin, or countertop, for a touch of refined audacity, Linea 48 will capture the attention of every guest.

Versatility is the watchword here. Modular in furniture and furnishings. It features spacious large drawers with elegant groove handles. Choose from a wide range of finishes and colors and express your style.



2
Composizione
Composition

LINEA 48



3
Composizione
Composition

LINEA 48

4
Composizione
Composition

LINEA 48

5

Composizione
Composition

LINEA 48



6

Composizione
Composition

LINEA 48



7

Composizione
Composition

LINEA 48





COLORI DISPONIBILI

COLORS AVAILABLE

TUNDRA Opaco Matt Lucido Glossy cod. 01TN cod. 02TN	CAPPUCCINO Opaco Matt Lucido Glossy cod. 01CU cod. 02CU	BIANCO Opaco Matt Lucido Glossy cod. 01BO cod. 02BO
ROSA HIMALAYA Opaco Matt Lucido Glossy cod. 01RH cod. 02RH	CORDA Opaco Matt Lucido Glossy cod. 01CD cod. 02CD	SALVIA Opaco Matt Lucido Glossy cod. 01SV cod. 02SV
BALTICO Opaco Matt Lucido Glossy cod. 01BT cod. 02BT	BURRO Opaco Matt Lucido Glossy cod. 01BR cod. 02BR	VERDE Opaco Matt Lucido Glossy cod. 01VE cod. 02VE
PRUGNA Opaco Matt Lucido Glossy cod. 01PR cod. 02PR	MENTA Opaco Matt Lucido Glossy cod. 01MN cod. 02MN	ZUCCA Opaco Matt Lucido Glossy cod. 01ZC cod. 02ZC
CIOCCOLATO Opaco Matt Lucido Glossy cod. 01CT cod. 02CT	SENAPE Opaco Matt Lucido Glossy cod. 01SN cod. 02SN	TURCHESE Opaco Matt Lucido Glossy cod. 01TR cod. 02TR
GRIGIO Opaco Matt Lucido Glossy cod. 01GR cod. 02GR	SABBIA Opaco Matt Lucido Glossy cod. 01SB cod. 02SB	ARANCIO Opaco Matt Lucido Glossy cod. 01AA cod. 02AA
NERO Opaco Matt Lucido Glossy cod. 01NR cod. 02NR	CANAPA Opaco Matt Lucido Glossy cod. 01CN cod. 02CN	PIETRA Opaco Matt Lucido Glossy cod. 01PE cod. 02PE
AVIO Opaco Matt Lucido Glossy cod. 01AV cod. 02AV	ARGILLA Opaco Matt Lucido Glossy cod. 01FN cod. 02FN	

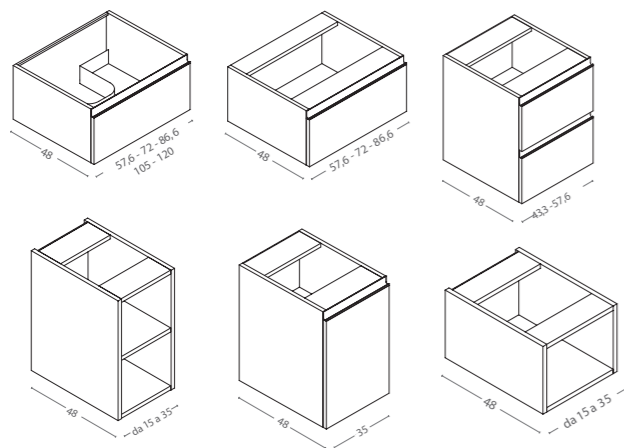

IT

Le maniglie a gola sono pratiche ed eleganti, caratterizzano il design della collezione. Un'esperienza tattile oltre che estetica.

ENG

The groove handles are practical and elegant, characterizing the design of the collection. A tactile experience as well as aesthetic.

IT

I cassetti sono capienti e possono essere corredati di accessori multifunzione.

ENG

The drawers are spacious and can be equipped with multifunctional accessories.

LEGNI MELAMINICI MELAMINE WOODS

BIANCO VERTICALE cod. VT	LARICE IRIS cod. IL
BASIC WHITE cod. BW	OLMO MONTANO cod. MO
ROVERE ADAMELLO cod. AR	OLMO PERLA cod. PO
QUERCIA BRUCIATO cod. BT	QUERCIA BIANCO cod. QB
ROVERE ROSA cod. RR	ANTRACITE cod. AN
CEMENTO cod. CT	
ESSENZA 4.0	
ROVERE MORO cod. MR	OLMO GRIGIO cod. GO

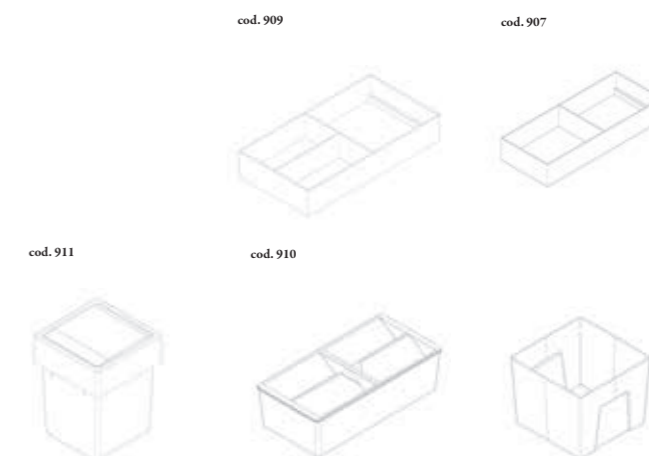

IT

L'ocritech è un materiale ampiamente collaudato. Una superficie spessa 1 cm su tutta la superficie del lavabo.

ENG

Ocritech is a widely tested material. A 1cm thick surface over the entire surface of the sink.

IT

Linea 48 offre una vasca ampia, alta e capiente. Comoda per tutte le attività.

ENG

Linea 48 offers a large, high and capacious basin. Convenient for all activities.

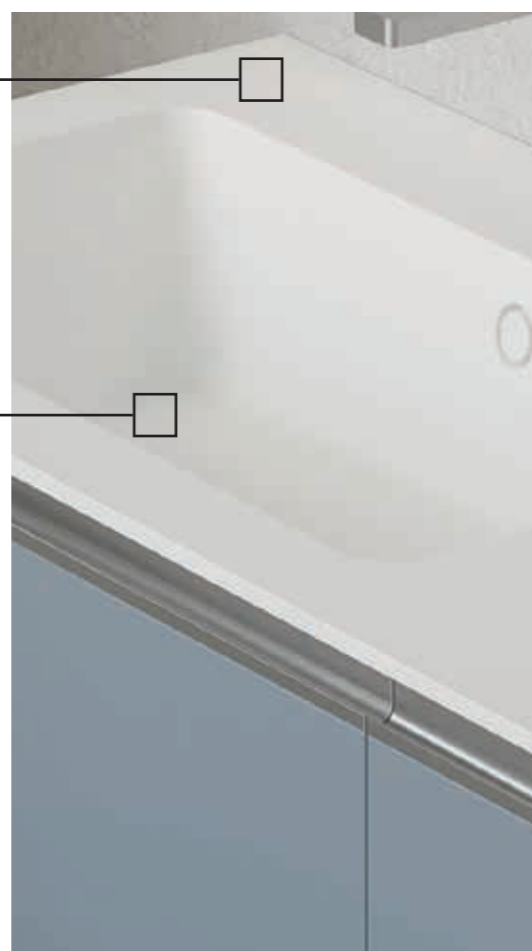

LE NOSTRE PROPOSTE

OUR PROPOSALS

LINEA 48 - 1

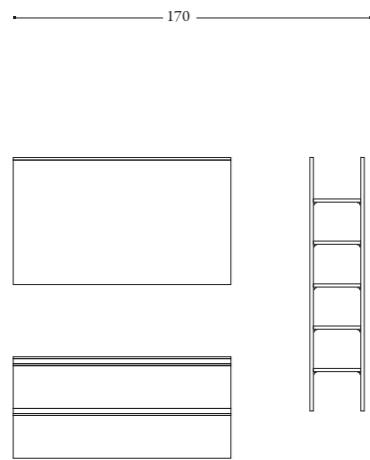

IT **003MB120** Base sottolavabo L120xP48xH55, due cassetti con maniglie a gola - **00T481MT** Top in ocritech spessore 10mm P48 Bianco opaco - **453VAS** Vasca integrata in ocritech L45xP33xH15 Bianco opaco - **3RML12070** Specchiera in alluminio L120xH70 con mensola e led integrato Gold - **3RUL30140** Pensile a giorno in alluminio L30xP22xH140 con ripiani in melaminico

ENG **003MB120** Washbasin base W120xD48xH55, two drawers with groove handles - **00T481MT** Ocritech top 10mm thick P48 Matt white - **453VAS** Integrated basin in ocritech W45xD33xH15 Matt white - **3RML12070** Aluminum mirror W120xH70 with shelf and integrated LED Gold - **3RUL30140** Open wall unit in aluminum W30xD22xH140 with melamine shelves

LINEA 48 - 2

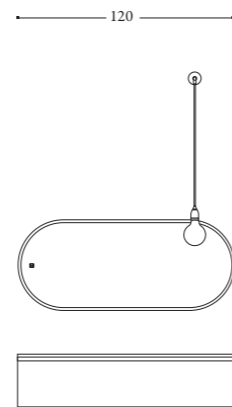

IT **003MBC120** Base sottolavabo L120xP48xH28, un cassetto con maniglia a gola - **00T481MT** Top in ocritech spessore 10mm P48 - **603VAS** Vasca integrata in ocritech L60xP33xH15 - **1216RSD** Specchio ovale L100xH50 reversibile con sabbiatura perimetrale retroilluminata, touch e dimmer integrato - **731** Lampada Bulbo con staffa per attacco a parete

ENG **003MBC120** Washbasin base W120xD48xH28, one drawer with groove handle - **00T481MT** Ocritech top 10mm thick P48 - **603VAS** Integrated basin in ocritech W60xD33xH15 - **1216RSD** Reversible oval mirror W100xH50 with backlit perimeter sandblasting, touch and integrated dimmer - **731** Bulbo lamp with bracket for wall attachment

LINEA 48 - 7

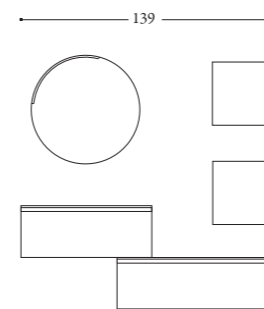

IT **003MBC73** Base sottolavabo L72xP48xH28, un cassetto con maniglia a gola - **00T481MT** Top in ocritech spessore 10mm P48 - **603VAS** Vasca integrata in ocritech L60xP33xH15 - **003CU88** Base L87xP48xH28, un cassetto con maniglia a gola - **00T481MT** Top in ocritech spessore 10mm P48 - **1215** Specchio tondo a giorno Ø100 - **741** Lampada mod. Moon - **3MM3520** Contenitore in metallo a giorno L35xP20xH35

ENG **003MBC73** Washbasin base W72xD48xH28, one drawer with groove handle - **00T481MT** Ocritech top 10mm thick P48 - **603VAS** Integrated basin in ocritech W60xD33xH15 - **003CU88** Base W87xD48xH28, one drawer with groove handle - **00T481MT** Ocritech top 10mm thick P48 - **1215** Round open mirror Ø100 - **741** Lamp mod. Moon - **3MM3520** Matt black metal container W35xD20xH35 with magnetic bottom

LINEA 48 - 5



IT **003MB60** Base sottolavabo L58xP48xH55, due cassetti con maniglie a gola - **00T481MT** Top in ocritech spessore 10mm P48 - **40LCD** Lavabo in ceramica d'appoggio Ø40xH17 - **1216CM** Specchio ovale L50xH100 con cornice perimetrale in metallo nero ed illuminazione integrata

ENG **003MB60** Washbasin base W58xD48xH55, two drawers with groove handles - **00T481MT** Ocritech top 10mm thick P48 - **1216CM** Oval mirror W50xH100 with black metal perimeter frame and integrated lighting

LINEA 48 - 3

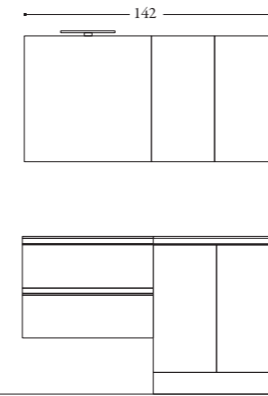

IT **003MB73** Base sottolavabo L72xP48xH55, due cassetti con maniglie a gola - **227687GM** Base vano lavatrice L70xP65xH87 con due ante - **00T651CP** Top in ocritech spessore 10mm P65 con cambio di profondità - **603VAS** Vasca integrata in ocritech L60xP33xH15 - **1370** Specchio a giorno mod. Easy L70xH70 - **737** Lampada mod. Diamond L45cm - **22973** Pensile L70xP37xH70 con due ante

ENG **003MB73** Washbasin base W72xD48xH55, two drawers with groove handles - **227687GM** Washing machine compartment base W70xD65xH87 with two doors - **00T651CP** Ocritech top 10mm thick P65 with depth change - **603VAS** Integrated basin in ocritech W60xD33xH15 - **1370** Open mirror mod. Easy W70xH70 - **737** Lamp mod. Diamond L45cm - **22973** Wall unit W70xD37xH70 with two doors

LINEA 48 - 4

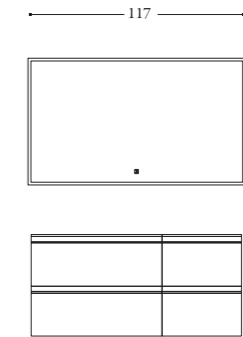

IT **003MB73** Base sottolavabo L72xP48xH55, due cassetti con maniglie a gola brill - **34555** Base 2 cassetti L45xP48xH55 con maniglia a gola brill - **00T481MT** Top in ocritech spessore 10mm P48 - **603VAS** Vasca integrata in ocritech L60xP33xH15 - **13120RSD** Specchio mod. Perimetro L120xH70 con sabbiatura perimetrale retroilluminata, touch e dimmer integrato

ENG **003MB73** Recessed washbasin base W72xD48xH55, due cassetti con maniglie a gola brill - **34555** Base 2 cassetti W45xD48xH55 with brill groove handle - **00T481MT** Ocritech top thickness 10mm P48 - **603VAS** Integrated basin in ocritech W60xD33xH15 - **13120RSD** Mirror mod. Perimeter W120xH70 with backlit perimeter sandblasting, touch and integrated dimmer

LINEA 48 - 6

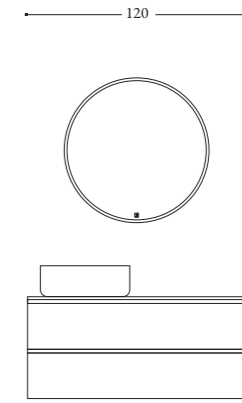

IT **003MB120** Base sottolavabo L120xP48xH55, due cassetti con maniglie a gola - **00T481MT** Top in ocritech spessore 10mm P48 - **5038LCD** Lavabo in ceramica d'appoggio L50xP38xH17 - **1215RSD** Specchio tondo a giorno Ø100 con sabbiatura perimetrale retroilluminata, touch e dimmer integrato

ENG **003MB120** Washbasin base W120xD48xH55, two drawers with groove handles - **00T481MT** Ocritech top 10mm thick P48 - **5038LCD** Countertop ceramic washbasin W50xD38xH17 - **1215RSD** Round open mirror Ø100 with backlit perimeter sandblasting, touch and integrated dimmer

LINEA 26

IT

Ecco Viola e il suo spazio felice: l'angolo verde del balcone durante il tramonto. Un momento in cui chiudere fuori il lavoro e il caos della città.

È qui che si prende cura delle piantine, nel comodo lavabo in ceramica Block con la griglia sospesa, con cui riesce agilmente a togliere la terra, sciacquare e travasare. Il cielo è rosa, la città bisbiglia, l'ora di cena si avvicina. Il basilico libera il suo aroma vivace.

ENG

Here's Viola and her happy space: the green corner of her balcony during sunset.

A moment in which to shut out the work and the chaos of the city. It's here that she takes care of the seedlings, in the convenient Block ceramic washbasin with the suspended grill, with which she can easily remove the soil, rinse and decant. The sky is pink, the city whispers, dinner time is approaching. Basil releases its lively aroma.



1

Composizione
Composition

LINEA 26

LINEA 26

5 m² 1:50

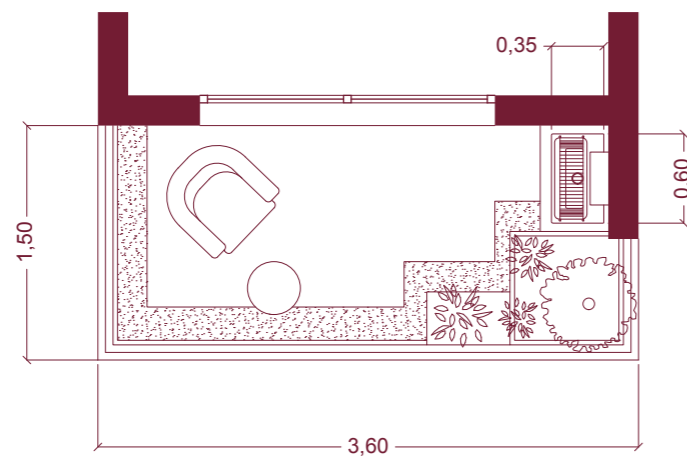

IT

Linea 26 supera ogni limite imposto dai piccoli spazi, dobbiamo solo liberare la fantasia. Una profondità ristretta appropriata per svariate situazioni: retrobotteghe, piccoli bagni, balconi, laboratori, studi medici, portici e giardini.

Nasce per accogliere il lavabo in ceramica Block, con una base profonda 26 cm che si allarga fino a 35 cm nel punto più alto, un bacino contenitivo alto 20 cm, adatto a ospitare lavori manuali e una pratica griglia sospesa. Tuttavia, può montare un piccolo lavamani in appoggio, a voi la scelta! Che voi desideriate un'installazione sospesa o da appoggio, Linea 26 è in grado di soddisfare ogni vostra esigenza estetica e funzionale. È la soluzione perfetta per coloro che cercano un punto acqua pratico per le attività di ogni giorno.

ENG

Linea 26 overcomes every limit imposed by small spaces, we just have to free our imagination. A narrow depth suitable for various situations: back rooms, small bathrooms, balconies, laboratories, doctors' offices, porches and gardens. Created to accommodate the Block ceramic washbasin, with a 26 cm deep base that widens up to 35 cm at the highest point, a 20 cm high containing basin, suitable for hosting manual work and a practical suspended grill. However, it can fit a small countertop hand basin, the choice is yours! Whether you want a suspended or countertop installation, Linea 26 is able to satisfy your every aesthetic and functional needs. It's the perfect solution for those looking for a practical water point for everyday activities.

2

Composizione
Composition

LINEA 26



3

Composizione
Composition

LINEA 26





4
Composizione
Composition
LINEA 26

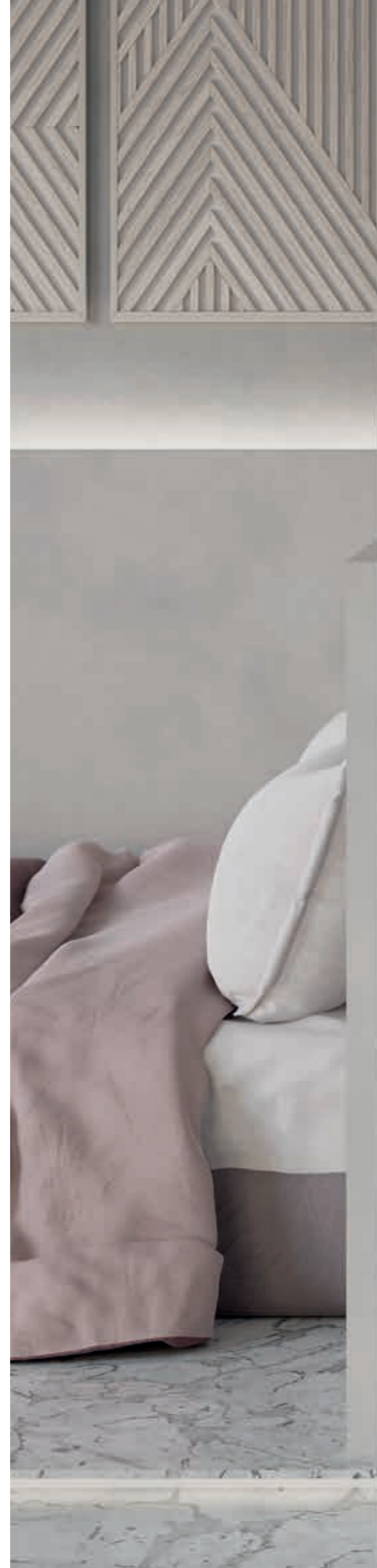

5
Composizione
Composition
LINEA 26





6

Composizione
Compositon

LINEA 26



IT

Le composizioni con Linea 26 sono modulari. Potete inserire pensili, specchi, specchi contenitore, luci led, lampade e mensole.

ENG

The compositions with Linea 26 are modular. You can insert wall units, mirrors, mirror cabinets, led lights, lamps and shelves.

COLORI DISPONIBILI

COLORS AVAILABLE

TUNDRA Opaco Matt Lucido Glossy cod. 01TN cod. 02TN	CAPPUCCINO Opaco Matt Lucido Glossy cod. 01CU cod. 02CU	BIANCO Opaco Matt Lucido Glossy cod. 01BO cod. 02BO
ROSA HIMALAYA Opaco Matt Lucido Glossy cod. 01RH cod. 02RH	CORDA Opaco Matt Lucido Glossy cod. 01CD cod. 02CD	SALVIA Opaco Matt Lucido Glossy cod. 01SV cod. 02SV
BALTICO Opaco Matt Lucido Glossy cod. 01BT cod. 02BT	BURRO Opaco Matt Lucido Glossy cod. 01BR cod. 02BR	VERDE Opaco Matt Lucido Glossy cod. 01VE cod. 02VE
PRUGNA Opaco Matt Lucido Glossy cod. 01PR cod. 02PR	MENTA Opaco Matt Lucido Glossy cod. 01MN cod. 02MN	ZUCCA Opaco Matt Lucido Glossy cod. 01ZC cod. 02ZC
CIOCCOLATO Opaco Matt Lucido Glossy cod. 01CT cod. 02CT	SENAPE Opaco Matt Lucido Glossy cod. 01SN cod. 02SN	TURCHESE Opaco Matt Lucido Glossy cod. 01TR cod. 02TR
GRIGIO Opaco Matt Lucido Glossy cod. 01GR cod. 02GR	SABBIA Opaco Matt Lucido Glossy cod. 01SB cod. 02SB	ARANCIO Opaco Matt Lucido Glossy cod. 01AA cod. 02AA
NERO Opaco Matt Lucido Glossy cod. 01NR cod. 02NR	CANAPA Opaco Matt Lucido Glossy cod. 01CN cod. 02CN	PIETRA Opaco Matt Lucido Glossy cod. 01PE cod. 02PE
AVIO Opaco Matt Lucido Glossy cod. 01AV cod. 02AV	ARGILLA Opaco Matt Lucido Glossy cod. 01FN cod. 02FN	

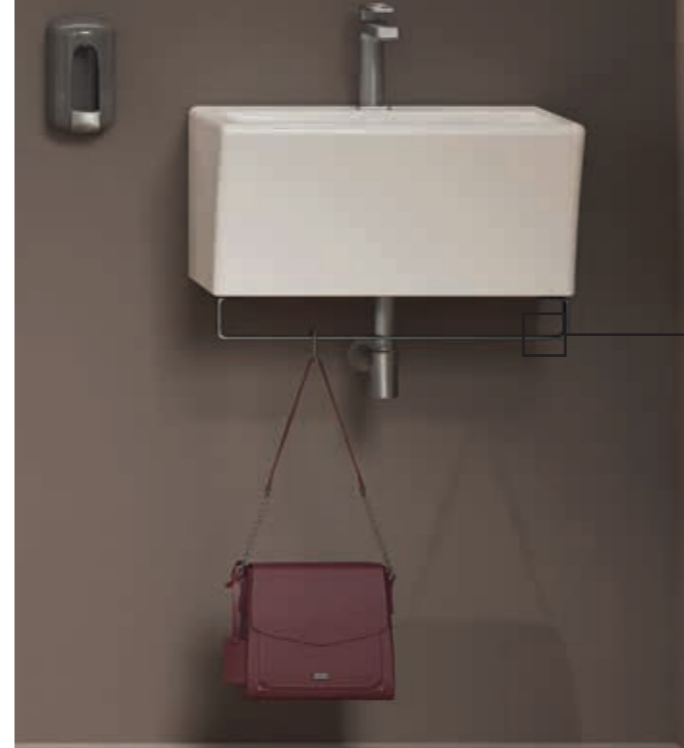

IT

Il lavabo in ceramica Block può essere montato anche sospeso, senza mobile. In questa versione possiamo aggiungere un pratico porta asciugamani fissato sotto il lavabo.

ENG

The Block ceramic washbasin can also be mounted suspended, without furniture. In this version we can add a practical towel holder fixed under the sink.

IT

Questa utile griglia sospesa è realizzata con un metallo durevole, resistente all'acqua e agli agenti esterni, come saponi e detersivi.

ENG

This useful hanging grill is made of durable metal, resistant to water and external agents, such as soaps and detergents.



IT

Tutta la comodità di una vasca alta 20 cm, c'è spazio per sciacquare e per usare la griglia sospesa.

ENG

All the convenience of a 20cm high basin, there is space to rinse and to use the hanging grill.

LEGGI MELAMINICI MELAMINE WOODS

BIANCO VERTICALE cod. VT	LARICE IRIS cod. IL
BASIC WHITE cod. BW	OLMO MONTANO cod. MO
ROVERE ADAMELLO cod. AR	OLMO PERLA cod. PO
QUERCIA BRUCIATO cod. BT	QUERCIA BIANCO cod. QB
ROVERE ROSA cod. RR	ANTRACITE cod. AN
CEMENTO cod. CT	
ESSENZA 4.0	
ROVERE MORO cod. MR	OLMO GRIGIO cod. GO

IT

Il lavabo Block ha una profondità di 26 cm alla base e di 35 cm nella parte superiore. Misure che lo rendono adatto ai piccoli spazi, senza rinunciare alla capienza del bacino.

ENG

The Block washbasin has a depth of 26 cm at the base and 35 cm at the top. Dimensions that make it suitable for small spaces, without sacrificing the capacity of the basin.



LE NOSTRE PROPOSTE

OUR PROPOSALS

LINEA 26 - 1

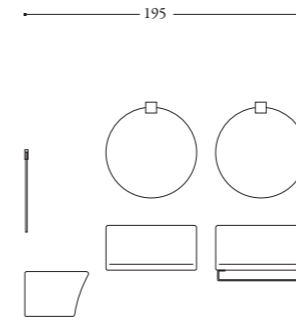

- IT **1663BK** Lavabo in ceramica Block L60xP35xH25 - **60PRT** Portasalviette in metallo per lavabo Block da 60 - **1214** Specchio mod. Diametro Ø 60 - **739** Lampada mod. TIT
- ENG **1663BK** Block ceramic washbasin W60xD35xH25 - **60PRT** Metal towel holder for Block 60 washbasin - **1214** Mirror mod. Diameter Ø 60 - **739** Lamp mod. TIT

LINEA 26 - 2



- IT **1663BK** Lavabo in ceramica Block L60xP35xH25 - **16GR60** Griglia per doppio fondo Block da 60 - **3RM35** Mensola in alluminio L35xP12
- ENG **1663BK** Block ceramic washbasin W60xD35xH25 - **16GR60** Block 60 double bottom grill - **3RM35** Aluminum shelf W35xP12

LINEA 26 - 3

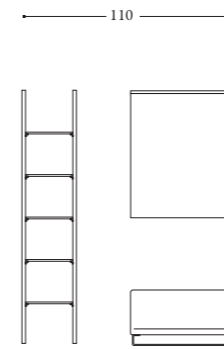

- IT **1663BK** Lavabo in ceramica Block L60xP35xH25 - **60PRT** Portasalviette in metallo per lavabo Block da 60 - **3RML6070** Specchiiera in alluminio Road L60xH70 con mensola e led integrato - **3RUV30140** Pensile a giorno in alluminio L30xP22xH140 con ripiani in vetro fumè
- ENG **1663BK** Block ceramic washbasin W60xD35xH25 - **60PRT** Metal towel holder for Block 60 washbasin - **3RML6070** Road W60xH70 aluminum mirror with shelf and integrated LED - **3RUV30140** Open wall unit in aluminum W30xD22xH140 with smoked glass shelves

LINEA 26 - 4

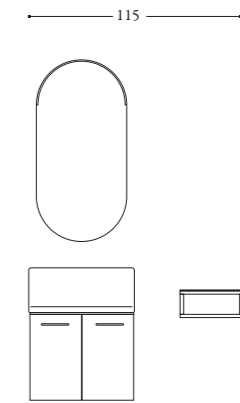

- IT **16MB625** Base porta lavabo Block L58xP26xH47 sospesa 2 ante - **16TO26** Top in ocritech spessore 10mm P26 - **1SCATOP1** Sagoma per alloggiamento lavabo su top - **1663BK** Lavabo in ceramica Block L60xP35xH25 - **1216CM** Specchio ovale L50xH100 con cornice perimetrale in metallo nero ed illuminazione integrata - **3MLOT35** Mensola multifunzione in alluminio con ripiano in ocritech L35xP15xH15
- ENG **16MB625** Block recessed washbasin base W58xD26xH47 suspended 2 doors - **16TO26** Ocritech top 10mm thickness P26 - **1SCATOP1** Template for washbasin placement on top - **1663BK** Block ceramic washbasin W60xD35xH25 - **1216CM** Oval mirror W50xH100 with black metal perimeter frame and integrated lighting - **3MLOT35** Multifunctional aluminum shelving unit with ocritech shelf W35xD15xH15

LINEA 26 - 5



- IT **16MB625** Base porta lavabo Block L58xP26xH47 sospesa 2 ante - **16T26** Top in melaminico spessore 18mm P26 - **1SCATOP1** Sagoma per alloggiamento lavabo su top - **32LCD** Lavabo in ceramica d'appoggio L35xP25xH12,5 - **1216RSD** Specchio ovale L100xH50 reversibile con sabbiatura perimetrale retroilluminata, touch e dimmer integrato
- ENG **16MB625** Block recessed washbasin base W58xD26xH47 suspended 2 doors - **16T26** 18mm thick P26 melamine top - **1SCATOP1** Template for washbasin placement on top - **32LCD** Countertop ceramic washbasin W35xD25xH12,5 - **1216RSD** Reversible oval mirror W100xH50 with backlight perimeter sandblasting, touch and integrated dimmer

LINEA 26 - 6

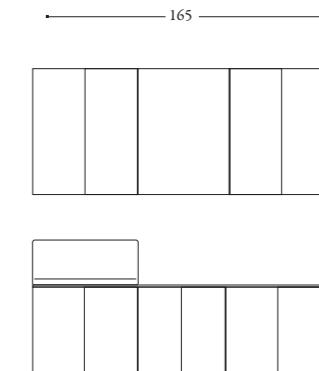

- IT **16MB625** Base porta lavabo Block L58xP26xH47 sospesa 2 ante - **16M525** Base L49xP26xH47 sospesa 2 ante - **16M625** Base L58xP26xH47 sospesa 2 ante - **P01** Meccanismo push to open - **16TO26** Top in ocritech spessore 10mm P26 - **1SCATOP1** Sagoma per alloggiamento lavabo su top - **1663BK** Lavabo in ceramica Block L60xP35xH25 - **22961** Pensile L58xP15xH70 2 ante - **1251** Pensile L50xP15xH70 1 anta
- ENG **16MB625** Block recessed washbasin base W58xD26xH47 suspended 2 doors - **16M525** Base W49xD26xH47 suspended 2 doors - **16M625** Base W58xD26xH47 suspended 2 doors - **P01** Push to open mechanism surcharge - **16TO26** Top in ocritech thickness 10mm P26 - **1SCATOP1** Template for washbasin placement on top - **1663BK** Block ceramic washbasin W60xD35xH25 - **22961** Wall unit W58xD15xH70 2 doors - **1251** Wall unit W50xD15xH70 1 door



1
Composizione
Composition

LINEA 55

LINEA 55

8 m² 1:50

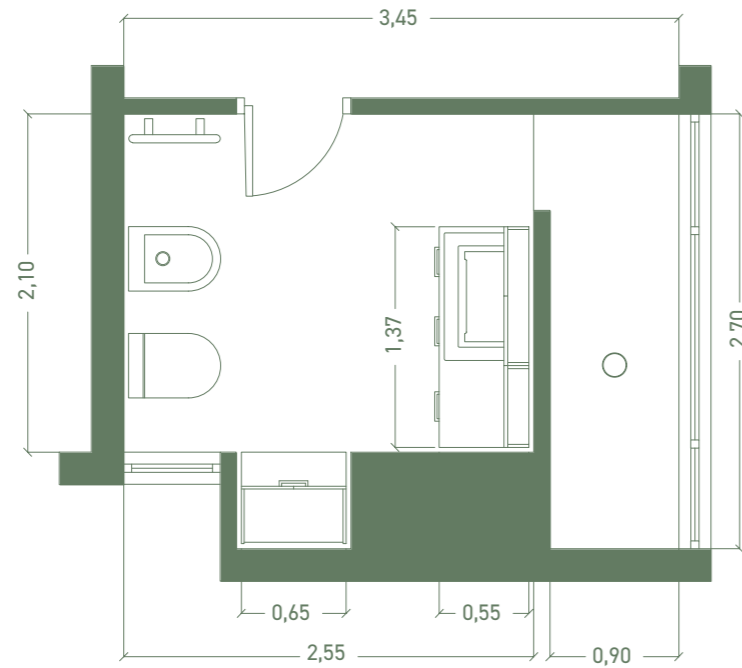

IT

Immaginate un bagno, un bagno spazioso baciato dalla luce del sole. Sulla parete c'è il mobile da bagno della Linea 55, dai suoi 55 centimetri di profondità.

Dietro l'anta, caratterizzata da una finitura elegante, si nasconde il cesto per i panni, che scorre fuori quando ne hai bisogno. Funzionalità utile e discreta che elimina un ingombro scomodo per qualunque bagno.

La profondità di 55 cm, dunque, apre le porte a complementi d'arredo spaziosi e declinabili in svariate funzionalità, da bagno e da lavanderia.

Armadietti classici e specchiati, grandi lavabi (singoli o doppi) e vani inaspettati completano l'arredamento. Potete riporre comodamente oggetti d'uso quotidiano, come saponi, detersivi e tutto il necessario per l'igiene della casa.

ENG

Imagine a bathroom, a spacious bathroom bathed in sunlight. On the wall you can find the bathroom furniture of the Linea 55; from its 55 centimeters deep. Behind its doors, characterized by an elegant finish, the laundry basket hides, sliding out when you need it.

Useful and discreet feature that eliminates an uncomfortable hindrance for any bathroom. The depth of 55 cm, therefore, opens the doors to spacious furnishing accessories that can be declined in various functions, for a bathroom and for a laundry. Classic and mirrored cabinets, large washbasins (single or double) and unexpected compartments complete the decor. You can comfortably store everyday objects, such as soaps, detergents and everything you need for home hygiene.



2

Composizione
Composition

LINEA 55



3
Composizione
Composition
LINEA 55



4
Composizione
Composition
LINEA 55



5
Composizione
Composition

LINEA 55

6
Composizione
Composition

LINEA 55



7
Composizione
Composition

LINEA 55



8

Composizione
Composition

LINEA 55

9

Composizione
Composition

LINEA 55

10

Composizione
Composition

LINEA 55





11

Composizione
Compositon

LINEA 55

12

Composizione
Compositon

LINEA 55



13
Composizione
Composition

LINEA 55

14
Composizione
Composition

LINEA 55



15

Composizione
Composition

LINEA 55





**COLORI
DISPONIBILI**

**COLORS
AVAILABLE**

TUNDRA Opaco Matt Lucido Glossy cod. 01TN cod. 02TN	CAPPUCCINO Opaco Matt Lucido Glossy cod. 01CU cod. 02CU	BIANCO Opaco Matt Lucido Glossy cod. 01BO cod. 02BO
ROSA HIMALAYA Opaco Matt Lucido Glossy cod. 01RH cod. 02RH	CORDA Opaco Matt Lucido Glossy cod. 01CD cod. 02CD	SALVIA Opaco Matt Lucido Glossy cod. 01SV cod. 02SV
BALTICO Opaco Matt Lucido Glossy cod. 01BT cod. 02BT	BURRO Opaco Matt Lucido Glossy cod. 01BR cod. 02BR	VERDE Opaco Matt Lucido Glossy cod. 01VE cod. 02VE
PRUGNA Opaco Matt Lucido Glossy cod. 01PR cod. 02PR	MENTA Opaco Matt Lucido Glossy cod. 01MN cod. 02MN	ZUCCA Opaco Matt Lucido Glossy cod. 01ZC cod. 02ZC
CIOCCOLATO Opaco Matt Lucido Glossy cod. 01CT cod. 02CT	SENAPE Opaco Matt Lucido Glossy cod. 01SN cod. 02SN	TURCHESE Opaco Matt Lucido Glossy cod. 01TR cod. 02TR
GRIGIO Opaco Matt Lucido Glossy cod. 01GR cod. 02GR	SABBIA Opaco Matt Lucido Glossy cod. 01SB cod. 02SB	ARANCIO Opaco Matt Lucido Glossy cod. 01AA cod. 02AA
NERO Opaco Matt Lucido Glossy cod. 01NR cod. 02NR	CANAPA Opaco Matt Lucido Glossy cod. 01CN cod. 02CN	PIETRA Opaco Matt Lucido Glossy cod. 01PE cod. 02PE
AVIO Opaco Matt Lucido Glossy cod. 01AV cod. 02AV	ARGILLA Opaco Matt Lucido Glossy cod. 01FN cod. 02FN	

IT

Mobili spaziosi e tante combinazioni possibili, sospese e a terra, a giorno o con ante.

ENG

Spacious furniture and many possible combinations, suspended and floor-standing, open or with doors.

IT

Disponibile il piano in ocritech, facile da pulire, o in finitura legno, per uno stile autentico. Dimensioni con taglio a misura.

ENG

Available top in ocritech, easy to clean, or in wood finishes, for an authentic style. Dimensions with cut to size.

IT

Il cesto nascosto aggiunge funzionalità al bagno. Esiste in due versioni: estraibile o a ribalta.

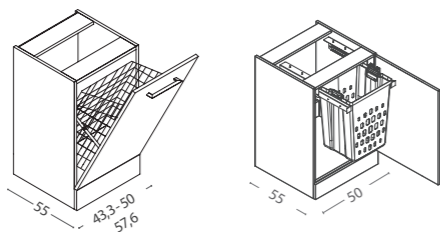

ENG

The hidden basket adds functionality to the bathroom. It exists in two versions: pull-out or drop-leaf.

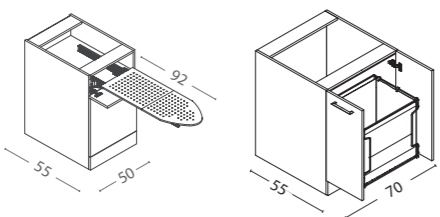

IT

Lo Specchio Touch con il tocco del dito permette di impostare luci fredde o calde con diversi livelli d'intensità.

ENG

The Touch Mirror with the touch of your finger allows you to set cold or warm lights with different intensity levels.

**LAVABI
WASH BASIN**

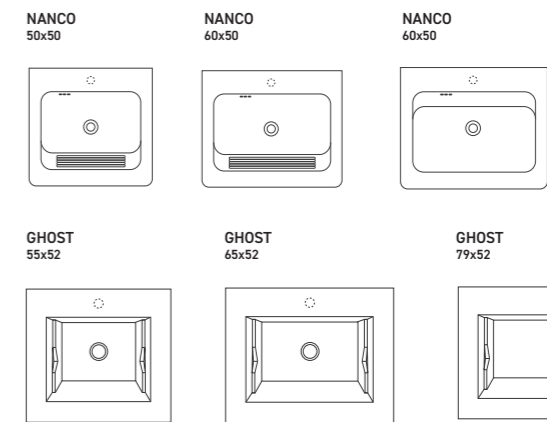

**LEGGI
MELAMINICI MELAMINE
WOODS**

BIANCO VERTICALE cod. VT	LARICE IRIS cod. IL
BASIC WHITE cod. BW	OLMO MONTANO cod. MO
ROVERE ADAMELLO cod. AR	OLMO PERLA cod. PO
QUERCIA BRUCIATO cod. BT	QUERCIA BIANCO cod. QB
ROVERE ROSA cod. RR	ANTRACITE cod. AN
CEMENTO cod. CT	
ESSENZA 4.0	
ROVERE MORO cod. MR	OLMO GRIGIO cod. GO

IT

Il lavabo in ceramica Ghost è un connubio di funzionalità ed estetica, dispone di un piano rimovibile in ocritech per la doppia profondità. 14+14 cm.

ENG

The Ghost ceramic washbasin is a combination of functionality and aesthetics, it features a convenient removable ocritech top for double depth. 14+14 cm.



LE NOSTRE PROPOSTE

OUR PROPOSALS

LINEA 55 - 1

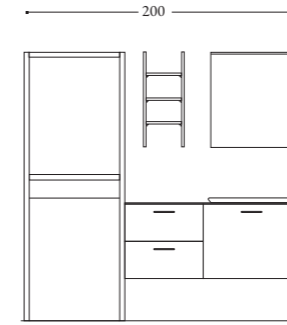

- IT** LHC65198 Colonna spessorata L70xP65xH198 per inserimento lavatrice/asciugatrice - LHCT170 Kit cassetto estraibile x colonna spessorata, con frontale H15 - 265555 Base sospesa 2 cassetti L58xP55xH55 - 23ML755 Base sottolavabo sospesa con cassetto L72xP55xH55 - 00T551MT Top in ocritech spessore 10mm P55 - ISCATOP1 Sagoma per alloggio lavabo su top - 4GT65 Lavabo in ceramica Ghost L65xP52 - 3RUL3070 Pensile a giorno in alluminio L30xP22xH70 con ripiani in legno - 3RML6070 Specchiera in alluminio Road L60xH70 con mensola e led integrato
- ENG** LHC65198 Thickened column W70xD65xH198 for inserting washing machine/dryer - LHCT170 Extractable drawer kit for Thickened column, with H15 front - 265555 Suspended base 2 drawers W58xD55xH55 - 23ML755 Suspended recessed washbasin base with drawer W72xD55xH55 - 00T551MT Ocritech top thickness 10mm P55 - ISCATOP1 Template for washbasin placement on top - 4GT65 Ghost ceramic washbasin W65xD52 - 3RUL3070 Aluminum open wall unit W30xD22xH70 with wooden shelves - 3RML6070 Road aluminium mirror W60xH70 with shelf and integrated LED

LINEA 55 - 2

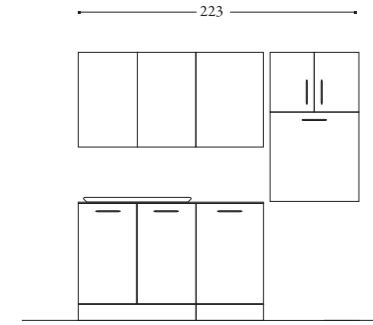

- IT** 22ML859 Base sottolavabo a terra due ante L87xP55xH87 - 2250CS559 Base a terra, un'anta, L50xP55xH87 con cesto porta biancheria estraibile - 00T551MT Top in ocritech spessore 10mm P55 - ISCATOP1 Sagoma per alloggio lavabo su top - 4GT75 Lavabo in ceramica Ghost L79xP52 - 229S81 Specchio pensile contenitore due ante L85xP15xH70 - 229S51 Specchio pensile contenitore un'anta L50xP15xH70 - 1463 Pensile L66xP37xH110 con due ante superiori ed un'anta inferiore a ribalta con cesto porta biancheria
- ENG** 22ML859 Floor standing recessed washbasin base two doors W87xD55xH87 - 2250CS559 Floor-standing base, one door, W50xD55xH87 with pull-out laundry basket - 00T551MT Ocritech top thickness 10mm P55 - ISCATOP1 Template for washbasin placement on top - 4GT75 Ghost ceramic washbasin W79xD52 - 229S81 Hanging container mirror two doors W85xD15xH70 - 229S51 Hanging mirror withtaining one door W50xD15xH70 - 1463 Wall unit W66xD37xH110 with two upper doors and a lower folding door with laundry basket

LINEA 55 - 3

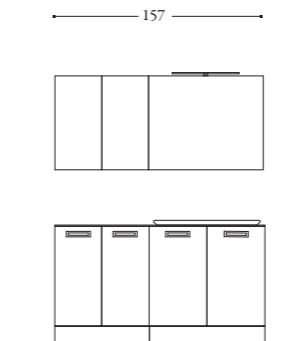

- IT** 227587 Base vano lavatrice L70xP55xH87 con due ante con maniglie ad incasso - 22ML859 Base sottolavabo a terra due ante L87xP55xH87 con maniglie ad incasso - 00T551MT Top in ocritech spessore 10mm P55 - ISCATOP1 Sagoma per alloggio lavabo su top - 4GT75 Lavabo in ceramica Ghost L79xP52 - 22972 Pensile L70xP22xH70 con due ante - 1385 Specchio a giorno mod. Easy L85xH70 - 719 Lampada mod. Luna 45
- ENG** 227587 Washing machine compartment base W70xD55xH87 with two doors with recessed handles - 22ML859 Floor standing recessed washbasin base two doors W87xD55xH87 with recessed handles - 00T551MT Ocritech top thickness 10mm P55 - ISCATOP1 Template for washbasin placement on top - 4GT75 Ghost ceramic washbasin W79xD52 - 22972 Wall unit W70xD22xH70 with two doors - 1385 Open mirror mod. Easy W85xH70 - 719 Lamp mod. Luna 45

LINEA 55 - 4

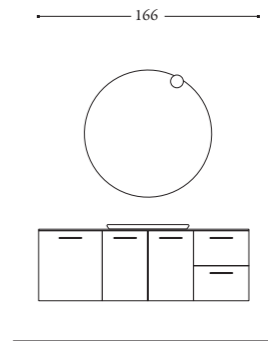

- IT** 2250555 Base sospesa un'anta L50xP55xH55 con un ripiano mobile interno - 22ML755 Base sottolavabo sospesa due ante L72xP55xH55 - 264555 Base sospesa due cassetti L44xP55xH55 - 00T551MT Top in ocritech spessore 10mm P55 - ISCATOP1 Sagoma per alloggio lavabo su top - 4GT65 Lavabo in ceramica Ghost L65xP52 - 1215 Specchio a giorno Ø 100 - 728 Lampada mod. Point
- ENG** 2250555 Suspended base one door W50xD55xH55 with an internal mobile shelf - 22ML755 Suspended recessed washbasin base with two doors W72xD55xH55 - 264555 Suspended base two drawers W44xD55xH55 - 00T551MT Ocritech top thickness 10mm P55 - ISCATOP1 Template for washbasin placement on top - 4GT65 Ghost ceramic washbasin W65xD52 - 1215 Open mirror Ø 100 - 728 Lamp mod. Point

LINEA 55 - 5

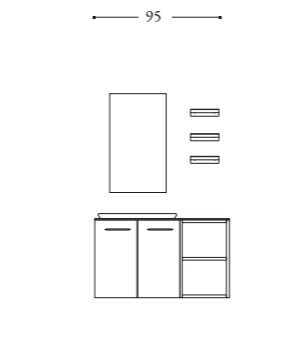

- IT** 22ML655 Base sottolavabo sospesa due ante L60xP55xH55 - 283555 Base sospesa Jolly a giorno L35xP55xH55 - 00T551MT Top in ocritech spessore 10mm P55 - ISCATOP1 Sagoma per alloggio lavabo su top - 4GT55 Lavabo in ceramica Ghost L55xP52 - 1340 Specchio a giorno mod. Easy L40xH70 - 3RM35 Mensola in alluminio L35xP12
- ENG** 22ML655 Suspended recessed washbasin base two doors W60xD55xH55 - 283555 Jolly suspended open base W35xD55xH55 - 00T551MT Ocritech top thickness 10mm P55 - ISCATOP1 Template for washbasin placement on top - 4GT55 Ghost ceramic washbasin W55xD52 - 1216RSD Reversible oval mirror W50xH100 with backlit perimeter sandblasting, touch and integrated dimmer - 3RM35 Aluminum shelf W35xP12

LINEA 55 - 6

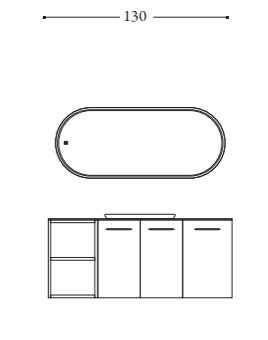

- IT** 283555 Base sospesa Jolly a giorno L35xP55xH55 - 22ML655 Base sottolavabo sospesa due ante L60xP55xH55 - 253555 Base sospesa un'anta L35xP55xH55 - 00T551MT Top in ocritech spessore 10mm P55 - ISCATOP1 Sagoma per alloggio lavabo su top - 4GT55 Lavabo in ceramica Ghost L55xP52 - 1216RSD Specchio ovale L50xH100 reversibile con sabbatura perimetrale retroilluminata, touch e dimmer integrato
- ENG** 283555 Jolly suspended open base W35xD55xH55 - 22ML655 Suspended recessed washbasin base two doors W60xD55xH55 - 253555 Suspended base one door W35xD55xH55 - 00T551MT Ocritech top thickness 10mm P55 - ISCATOP1 Template for washbasin placement on top - 4GT55 Ghost ceramic washbasin W55xD52 - 1216RSD Reversible oval mirror W50xH100 with backlit perimeter sandblasting, touch and integrated dimmer

LINEA 55 - 7

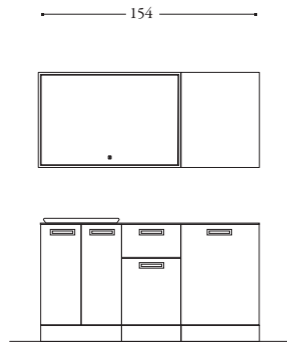

- IT 22ML659 Base sottolavabo due ante L60xP55xH87 con maniglie ad incasso - 234587 Base un cassetto ed un cassettone L44xP55xH87 con maniglie ad incasso - 2250CS559 Base a terra, un'anta, L50xP55xH87 con cesto porta biancheria estraibile con maniglie ad incasso - 00T551MT Top in ocritech spessore 10mm P55 - ISCATOP1 Sagoma per alloggiamento lavabo su top - 4GT55 Lavabo in ceramica Ghost L55xP52 - 13105RSD Specchio mod. Perimetro L105xH70 con sabbiatura perimetrale retroilluminata, touch e dimmer integrato - 229502 Pensile 1 anta L50xP22xH70
- ENG 22ML659 Recessed washbasin base two doors W60xD55xH87 with recessed handles - 234587 Base one drawer and one big drawer W44xD55xH87 with recessed handles - 2250CS559 Floor-standing base, one door, W50xD55xH87 with pull-out laundry basket with recessed handles - 00T551MT Ocritech top thickness 10mm P55 - ISCATOP1 Template for washbasin placement on top - 4GT55 Ghost ceramic washbasin W55xD52 - 13105RSD Mirror mod. Perimeter W105xH70 with backlit perimeter sandblasting, touch and integrated dimmer - 229502 Wall unit 1 door W50xD22xH70

LINEA 55 - 8

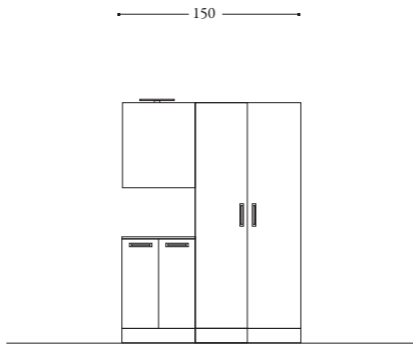

- IT 22ML659 Base sottolavabo L60xP55xH87 due ante - 00T551MT Top in ocritech spessore 10mm P55 (mt 0,60) - 473VAS Vasca integrata in ocritech L47xP39xH24 - 229S52 Specchio pensile contenitore L58xP22xH70 - 718 Lampada mod. Luna 30 - 2245198 Colonna L45xP55xH198 un'anta (2)
- ENG 22ML659 Recessed washbasin base W60xD55xH87 two doors - 00T551MT Ocritech top thickness 10mm P55 (mt 0,60) - 473VAS Integrated ocritech basin W47xD39xH24 - 229S52 Hanging container mirror W58xD22xH70 - 718 Lamp mod. Luna 30 - 2245198 Column W45xP55xH198 one door (2)

LINEA 55 - 13

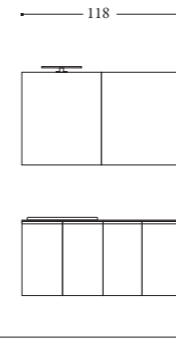

- IT 22ML655 Base sottolavabo sospesa due ante L60xP55xH55 con maniglia a gola brill - 255555 Base sospesa due ante L58xP55xH55 con un ripiano interno e maniglia a gola brill - 00T551MT Top in ocritech spessore 10mm P55 - ISCATOP1 Sagoma per alloggiamento lavabo su top - 855R Lavabo in ceramica Nanco L50xP50 con SIL rettificato - 229S61 Specchio pensile contenitore 1 anta L58xP15xH70 - 718 Lampada mod. Luna L30
- ENG 22ML655 Suspended recessed washbasin base two doors W60xD55xH55 with brill groove handle - 255555 Suspended base two doors W58xD55xH55 with an internal shelf and brill groove handle - 00T551MT Ocritech top thickness 10mm P55 - ISCATOP1 Template for washbasin placement on top - 855R Ceramic washbasin Nanco W50xP50 with grinded SIL - 229S61 Hanging container mirror 1 door W58xP15xH70 - 718 Lamp mod. Luna L30

LINEA 55 - 14

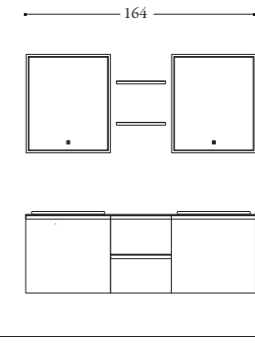

- IT 23ML655 Base sottolavabo sospesa con cassettoni L60xP55xH55 con maniglia a gola brill - 264555 Base sospesa due cassetti L44xP55xH55 con maniglia a gola brill - 00T551MT Top in ocritech spessore 10mm P55 - ISCATOP1 Sagoma per alloggiamento lavabo su top - 855R Lavabo in ceramica Nanco L50xP50 con SIL rettificato - 1360RSD Specchio L50xH70 reversibile con sabbiatura perimetrale retroilluminata, touch e dimmer integrato - 3RM35 Mensola in metallo L35xP12
- ENG 23ML655 Suspended recessed washbasin base with cassettoni W60xP55xH55 with brill groove handle - 264555 Suspended base two drawers W44xD55xH55 with brill groove handle - 00T551MT Ocritech top thickness 10mm P55 - ISCATOP1 Template for washbasin placement on top - 855R Ceramic washbasin Nanco W50xP50 with grinded SIL - 1360RSD Reversible mirror W60xH70 with backlit perimeter sandblasting, touch and integrated dimmer - 3RM35 Metal shelf W35xP12

LINEA 55 - 9

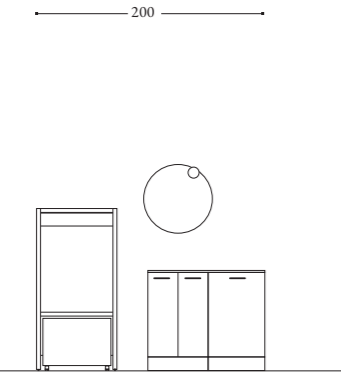

- IT 22ML659 Base sottolavabo L60xP55xH87 due ante - 2250CS659 Base L50xP65xH87 un'anta con cesto porta biancheria estraibile - 00T551MT Top in ocritech spessore 10mm P55 (mt 1,10) - 473VAS Vasca integrata in ocritech L47xP39xH24 - 1214 Specchio Diametro Ø60 - 728 Lampada mod. Point - LHC55140 Colonna spossorata per inserimento lavatrice L70xP55xH140 - LHCR6040 Contenitore su ruote L60xP52xH44
- ENG 22ML659 Recessed washbasin base W60xD55xH87 two doors - 2250CS659 Base W50xP65xH87 one door with pull-out laundry basket - 00T551MT Ocritech top thickness 10mm P55 (mt 1,10) - 473VAS Integrated ocritech basin W47xD39xH24 - 1214 Mirror diameter Ø60 - 728 Lamp mod. Point - LHC55140 Thickened column for inserting washing machine W70xD55xH140 - LHCR6040 Container on wheels W60xP52xH44

LINEA 55 - 10

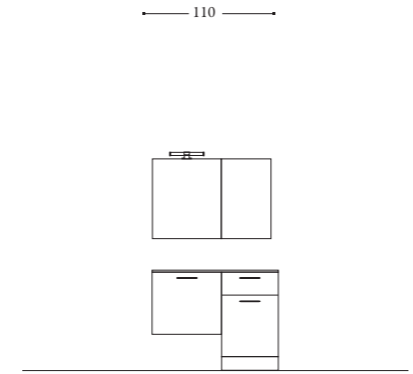

- IT 23ML655 Base sottolavabo sospesa L60xP55xH55 con cassettoni estraibili - 2250AS559 Base L50xP55xH87 con un'anta inferiore ed asse da stiro estraibile superiore - 00T551MT Top in ocritech spessore 10mm P55 (mt 1,10) - 473VAS Vasca integrata in ocritech L47xP37xH23 - 229S61 Specchio pensile contenitore L58xP22xH70 un'anta - 229S51 Specchio pensile contenitore L50xP22xH70 un'anta - 735 Lamp mod. Roll 30cm
- ENG 23ML655 Suspended recessed washbasin base W60xP55xH55 with pull-out big drawer - 2250AS559 Base W50xD55xH87 with a lower door and upper extractable ironing board - 00T551MT Ocritech top thickness 10mm P55 (mt 1,10) - 473VAS Integrated ocritech basin W47xP37xH23 - 229S61 Hanging container mirror W58xD22xH70 one door - 229S51 Hanging container mirror W50xP22xH70 one door - 735 Lamp mod. Roll 30cm

LINEA 55 - 15

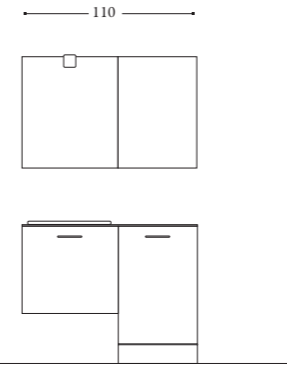

- IT 23ML655 Base sottolavabo sospesa con cassettoni L60xP55xH55 - 2250CR87 Base a terra, un'anta, L50xP55xH87 con cesto porta biancheria a ribalta - 00T551MT Top in ocritech spessore 10mm P55 - ISCATOP1 Sagoma per alloggiamento lavabo su top - 855R Lavabo in ceramica Nanco L50xP50 con SIL rettificato - 1360 Specchio a giorno mod. Easy L60xH70 - 729 Lampada mod. Cubo
- ENG 23ML655 Suspended recessed washbasin base with cassettoni W60xP55xH55 - 2250CR87 Floor standing base, one door, W50xD55xH87 with folding laundry basket - 00T551MT Ocritech top thickness 10mm P55 - ISCATOP1 Template for washbasin placement on top - 855R Ceramic washbasin Nanco W50xP50 with grinded SIL - 1360 Open mirror mod. Easy W60xH70 - 729 Lamp mod. Cubo

LINEA 55 - 11

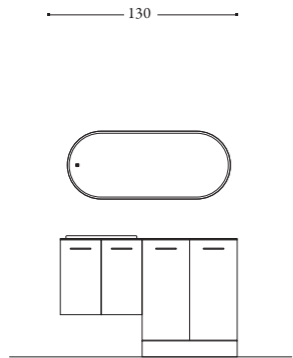

- IT 22ML655 Base sottolavabo sospesa due ante L60xP55xH55 - 227587 Base vano lavatrice L70xP55xH87 con due ante - 00T551MT Top in ocritech spessore 10mm P55 - ISCATOP1 Sagoma per alloggiamento lavabo su top - 855R Lavabo in ceramica Nanco L50xP50 con SIL rettificato - 1216RSD Specchio ovale L50xH100 reversibile con sabbiatura perimetrale retroilluminata, touch e dimmer integrato
- ENG 22ML655 Suspended recessed washbasin base two doors W60xD55xH55 - 227587 Washing machine compartment base W70xP55xH87 with two doors - 00T551MT Ocritech top thickness 10mm P55 - ISCATOP1 Template for washbasin placement on top - 855R Ceramic washbasin Nanco W50xP50 with grinded SIL - 1216RSD Reversible oval mirror W50xH100 with backlit perimeter sandblasting, touch and integrated dimmer

LINEA 55 - 12

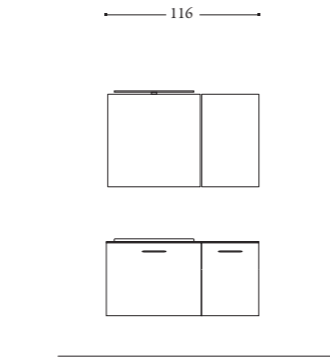

- IT 23ML755 Base sottolavabo sospesa con cassettoni L72xP55xH55 - 274555 Base sospesa un cassettoni L44xP55xH55 - 00T551MT Top in ocritech spessore 10mm P55 - ISCATOP1 Sagoma per alloggiamento lavabo su top - 865R Lavabo in ceramica Nanco L60xP50 con SIL rettificato - 22942 Pensile 1 anta L44xP22xH70 - 1370 Specchio a giorno mod. Easy L70xH70 - 737 Lampada mod. Diamond L45
- ENG 23ML755 Suspended recessed washbasin base with cassettoni W72xP55xH55 - 274555 Suspended base one drawer W44xP55xH55 - 00T551MT Ocritech top thickness 10mm P55 - ISCATOP1 Template for washbasin placement on top - 865R Ceramic washbasin Nanco W60xP50 with grinded SIL - 22942 1 door wall unit W44xP22xH70 - 1370 Open mirror mod. Easy W70xH70 - 737 Lamp mod. Diamond L45

LAUNDRY SHELF

IT

La cura della casa è tra le cose a cui la signora Anna tiene di più. L'aspetto dei mobili, le piante e le pulizie per lei sono delle priorità.

Alla sua età, la comodità è importante e la signora Anna vuole essere indipendente. Sta ripensando la casa in questo modo. Come il mobile con le rotelle del bagno, facile da portare in giro per le stanze. Può metterci i panni, gli oggetti d'uso quotidiano e i prodotti per la pulizia: è più facile eliminare i pesi.

“È bello, comodo ed economico”, dice, con una punta d'orgoglio, ogni volta che parla del suo nuovo bagno alle amiche del condominio.

ENG

Home care is among the things that Mrs. Anna cares about most. The appearance of the furniture, plants and cleaning are priorities for her.

At her age, comfort is important, and Mrs. Anna wants to be independent. She is rethinking the house in this way. Like the bathroom furniture with wheels, easy to carry around the rooms. She can put clothes, everyday objects and cleaning products in it: it's easier to eliminate weights.

“It's beautiful, comfortable and economical,” she says, with a hint of pride, every time she talks about her new bathroom to her friends of the condominium.

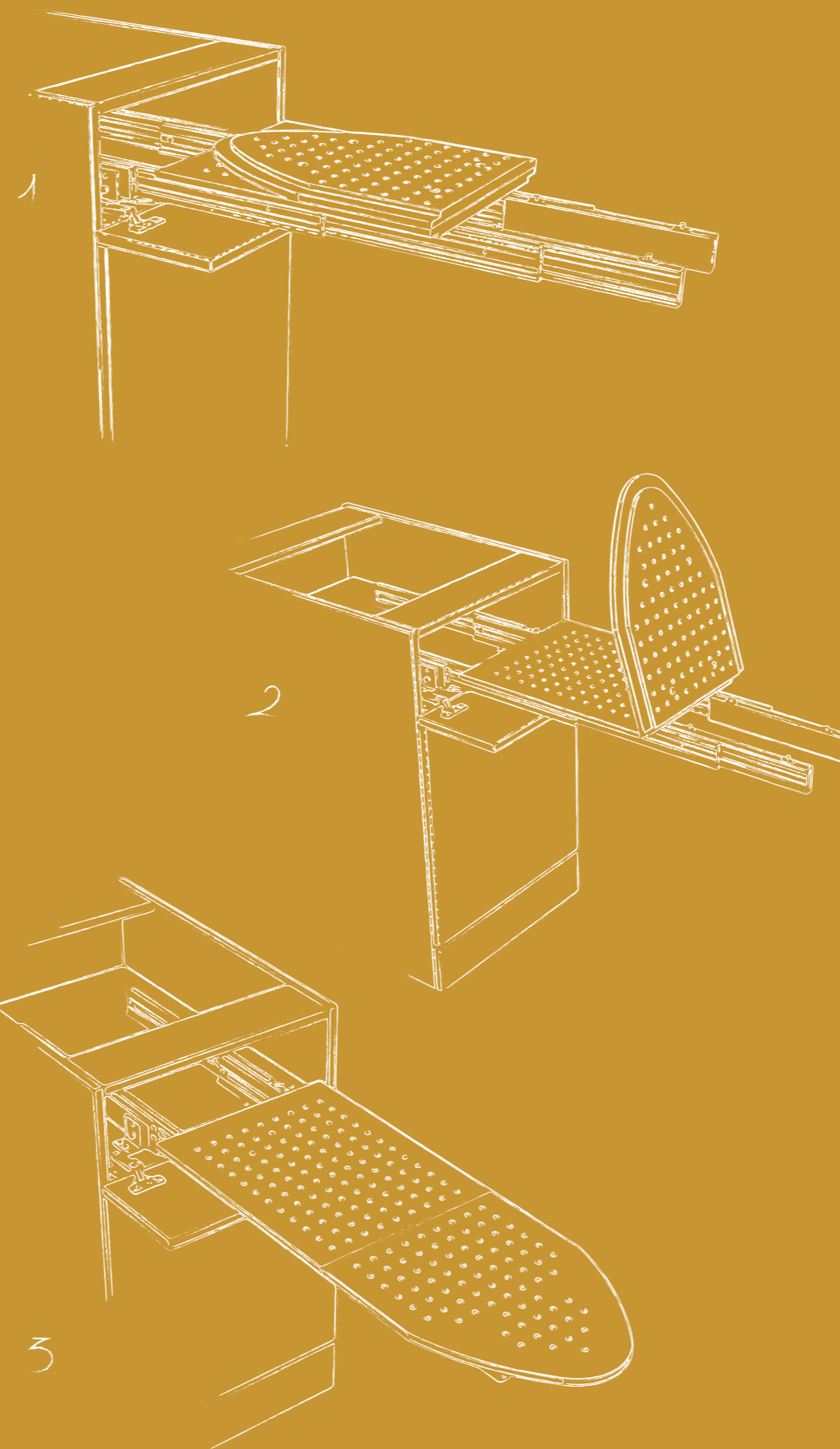



1

Composizione
Compositon

LAUNDRY SHELF



LAUNDRY SHELF

5 m² 1:50

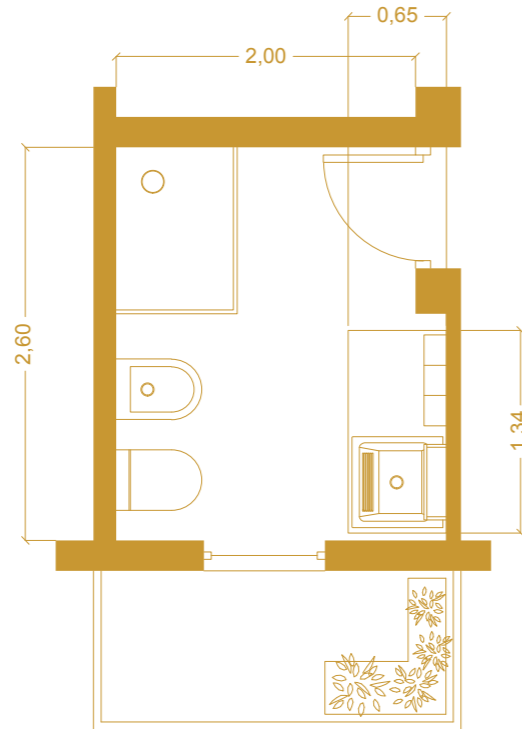

IT

Laundry Shelf aggiunge nuove funzionalità ai bagni di Xilon. Il mobile ha una struttura a ponte, che può essere lasciata vuota o riempita con dei pratici contenitori su ruote, da usare come portabiancheria.

Il mobile è spazioso, profondo 65 cm, e permette di installare il lavabo in ceramica Nanco 60x60 cm, disponibile sia con pareti lisce sia con lo strizzatoio. Agevolezza e funzione, per un uso pratico e dinamico anche come lavanderia.

ENG

Laundry Shelf adds new features to Xilon bathrooms. The piece of furniture has a bridge structure, which can be left empty or filled with practical containers on wheels, to be used as a laundry basket.

The cabinet is spacious, 65 cm deep, and allows you to install the Nanco 60x60 cm ceramic washbasin, available both with smooth walls and with the wringer. Ease and function, for practical and dynamic use also as a laundry.

2

Composizione
Composition

LAUNDRY SHELF





3

Composizione
Compositio

LAUNDRY SHELF



4

Composizione
Compositio

LAUNDRY SHELF



5

Composizione
Compositio

LAUNDRY SHELF

6

Composizione
Composition

LAUNDRY SHELF





IT

I contenitori su ruote sono maneggevoli e facili da trasportare.

ENG

Containers on wheels are handy and easy to transport.

COLORI DISPONIBILI

COLORS AVAILABLE

TUNDRA Opaco Matt cod. 01TN	CAPPUCCINO Opaco Matt cod. 01CU	BIANCO Opaco Matt cod. 0000
ROSA HIMALAYA Opaco Matt cod. 01RH	CORDA Opaco Matt cod. 01CD	SALVIA Opaco Matt cod. 01SV
BALTICO Opaco Matt cod. 01BT	BURRO Opaco Matt cod. 01BR	VERDE Opaco Matt cod. 01VE
PRUGNA Opaco Matt cod. 01PR	MENTA Opaco Matt cod. 01MN	ZUCCA Opaco Matt cod. 01ZC
CIOCCOLATO Opaco Matt cod. 01CT	SENAPE Opaco Matt cod. 01SN	TURCHESE Opaco Matt cod. 01TR
GRIGIO Opaco Matt cod. 01GR	SABBIA Opaco Matt cod. 01SB	
NERO Opaco Matt cod. 01NR	ARANCIO Opaco Matt cod. 01AA	
PIETRA Opaco Matt cod. 01PE	CANAPA Opaco Matt cod. 01CN	
AVIO Opaco Matt cod. 01AV	ARGILLA Opaco Matt cod. 01FN	

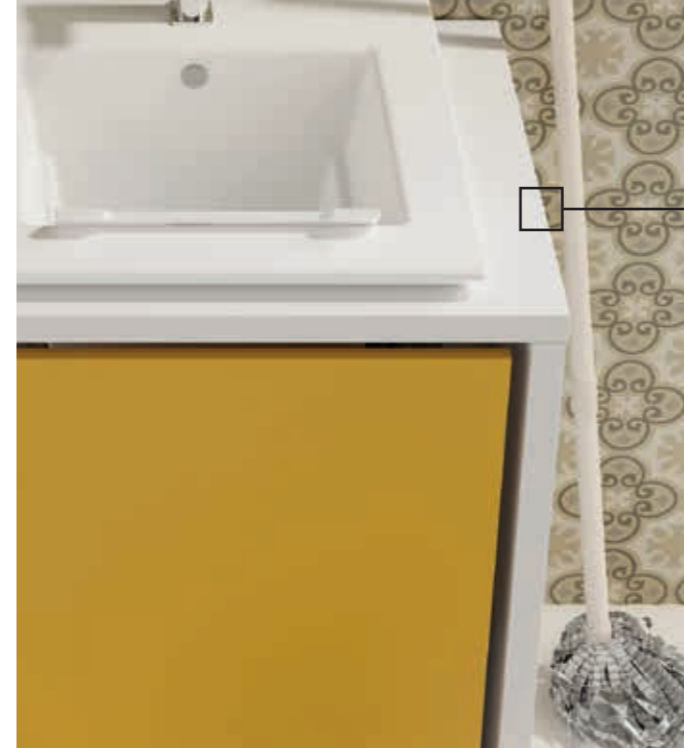

IT

Che sia un primo bagno, un secondo bagno o una lavanderia, Laundry Shelf esiste in due profondità: 46 e 55 cm.

ENG

Whether it is a first bathroom, a second bathroom or a laundry room, Laundry Shelf exists in two depths: 46 and 55 cm.

LEGNI MELAMINICI MELAMINE WOODS

BASIC WHITE cod. BW	ROVERE ROSA cod. RR	CEMENTO cod. CT
-------------------------------	-------------------------------	---------------------------

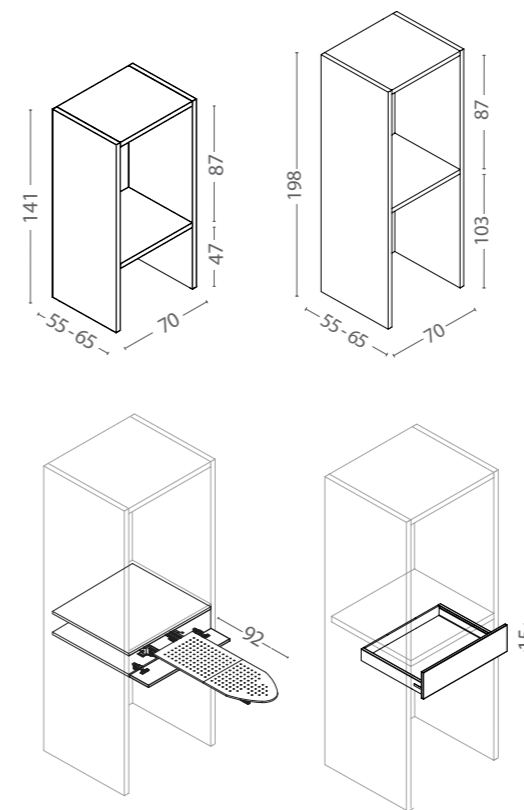

IT

Gli specchi contenitore sfruttano la superficie occupata della parete come ulteriore spazio in cui organizzare le proprie cose.

ENG

Container mirrors take advantage of the occupied surface of the wall as additional space in which to organize your things.



LE NOSTRE PROPOSTE

OUR PROPOSALS

LAUNDY SHELF - 1

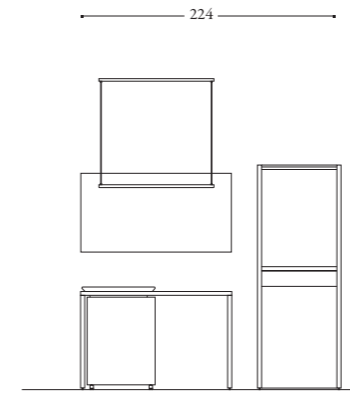

- IT **LH13455F2** Struttura a ponte spessorata L134xP55 c/scasso per lavabo Nanco 50x50 sil o Ghost 65x52 - **4GT65** Lavabo in ceramica Ghost 65x52 - **LHCR6080** Contenitore su ruote L60xP52xH85 - **13120** Specchio a giorno mod. Easy L120xH70 - **738** Lampada da soffitto mod. Ambient L80 - **LHC65198** Colonna spessorata per inserimento lavatrice/asciugatrice L70xP65xH198 - **LHAS70** Kit asse da stiro estraibile per colonna spessorata - **LHAA70** Kit asta appendiabiti
- ENG **LH13455F2** Thickened bridge structure W134xD55 w/ cut-out for Nanco 50x50 sil or Ghost 65x52 washbasin - **4GT65** Ceramic washbasin Ghost 65x52 - **LHCR6080** Container on wheels W60xP52xH85 - **13120** Open mirror mod. Easy W120xH70 - **738** Ceiling lamp mod. Ambient L80 - **LHC65198** Thickened column for inserting washing machine/dryer W70xD65xH198 - **LHAS70L** Removable ironing board kit for thickened column - **LHAA70** Clothes rail kit

LAUNDY SHELF - 2

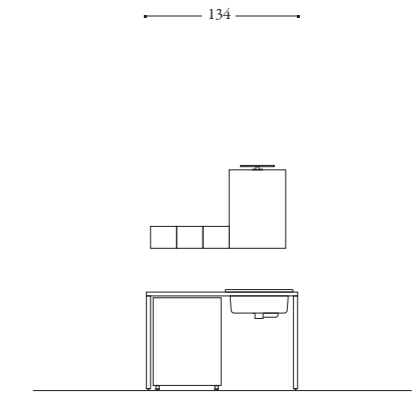

- IT **LH13465F3** Struttura a ponte spessorata L134xP55 c/scasso per lavabo Nanco 60x60 sil - **866R** Lavabo in ceramica Nanco 60x60 rettificato con SIL - **LHCR6080** Contenitore su ruote L60xP52xH85 - **229561** Specchio pensile contenitore un'anta L58xP15xH70 - **718** Lampada mod. Luna L30 - **3CM2015** Contenitore in metallo Nero reversibile L20xP15xH70
- ENG **LH13465F3** Thickened bridge structure W134xD65 with cut-out for Nanco 60x60 sil washbasin - **866R** Ceramic washbasin Nanco 60x60 grinded with SIL - **LHCR6080** Container on wheels W60xP52xH85 - **229561** Hanging container mirror one door W58xP15xH70 - **718** Lamp mod. Luna L30 - **3CM2015** Reversible black metal container W20xD15xH70

LAUNDY SHELF - 3

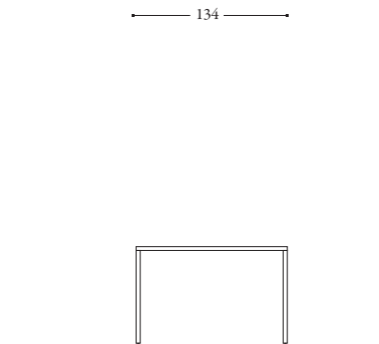

- IT **LH13465SF** Struttura a ponte spessorata L134xP65xH92 no foro
- ENG **LH13465SF** Thickened bridge structure W134xP65xH92 no hole

LAUNDY SHELF - 4

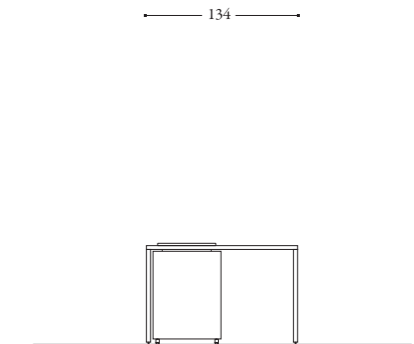

- IT **LH13455F1** Struttura a ponte spessorata L134xP65 c/scasso per lavabo Nanco 50x50 sil o Ghost 65x52 - **855R** Lavabo in ceramica Nanco 50x50 rettificato con SIL - **LHCR6080** Contenitore su ruote L60xP52xH85
- ENG **LH13455F1** Thickened bridge structure W134xP65 w/ cut-out per lavabo Nanco 50x50 sil o Ghost 65x52 - **855R** Ceramic washbasin Nanco 50x50 grinded with SIL - **LHCR6080** Container on wheels W60xP52xH85

LAUNDY SHELF - 5

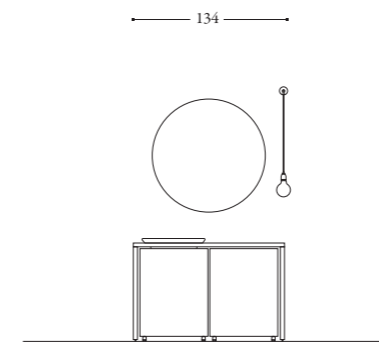

- IT **LH13455F1** Struttura a ponte spessorata L134xP65 c/scasso per lavabo Nanco 50x50 sil o Ghost 65x52 - **4GT65** Lavabo in ceramica Ghost 65x52 - **LHCR6080** Contenitore su ruote L60xP52xH85 (2) - **1215** Specchio tondo a giorno Ø100 - **731** Lampada Bulbo con staffa per attacco a parete
- ENG **LH13455F1** Thickened bridge structure W134xP65 w/ cut-out for Nanco 50x50 sil or Ghost 65x52 washbasin - **4GT65** Ceramic washbasin Ghost 65x52 - **LHCR6080** Container on wheels W60xP52xH85 - **1215** Round open mirror Ø100 - **731** Bulbo lamp with bracket for wall attachment

LAUNDY SHELF - 6

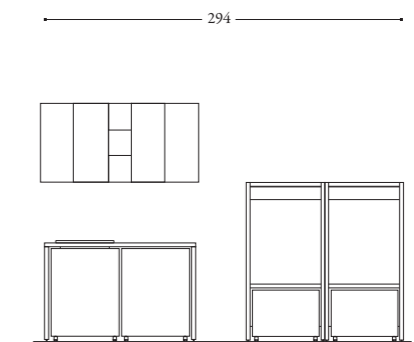

- IT **LH13455F1** Struttura a ponte spessorata L134xP65 c/scasso per lavabo Nanco 50x50 sil o Ghost 65x52 - **855R** Lavabo in ceramica Nanco 50x50 rettificato con SIL - **22961** Pensile 2 ante L58xP15xH70 - **3CM2015** Contenitore in metallo Nero reversibile L20xP15xH70 - **LHC55140** Colonna spessorata per inserimento lavatrice L70xP55xH140 (2) - **LHCR6040** Contenitore su ruote L60xP52xH44
- ENG **LH13455F1** Thickened bridge structure W134xP65 w/ cut-out for Nanco 50x50 sil or Ghost 65x52 washbasin - **855R** Ceramic washbasin Nanco 50x50 grinded with SIL - **22961** Wall unit 2 doors W58xP15xH70 - **3CM2015** Reversible black metal container W20xP15xH70 - **LHC55140** Thickened column for washing machine insertion W70xP55xH140 (2) - **LHCR6040** Container on wheels W60xP52xH44

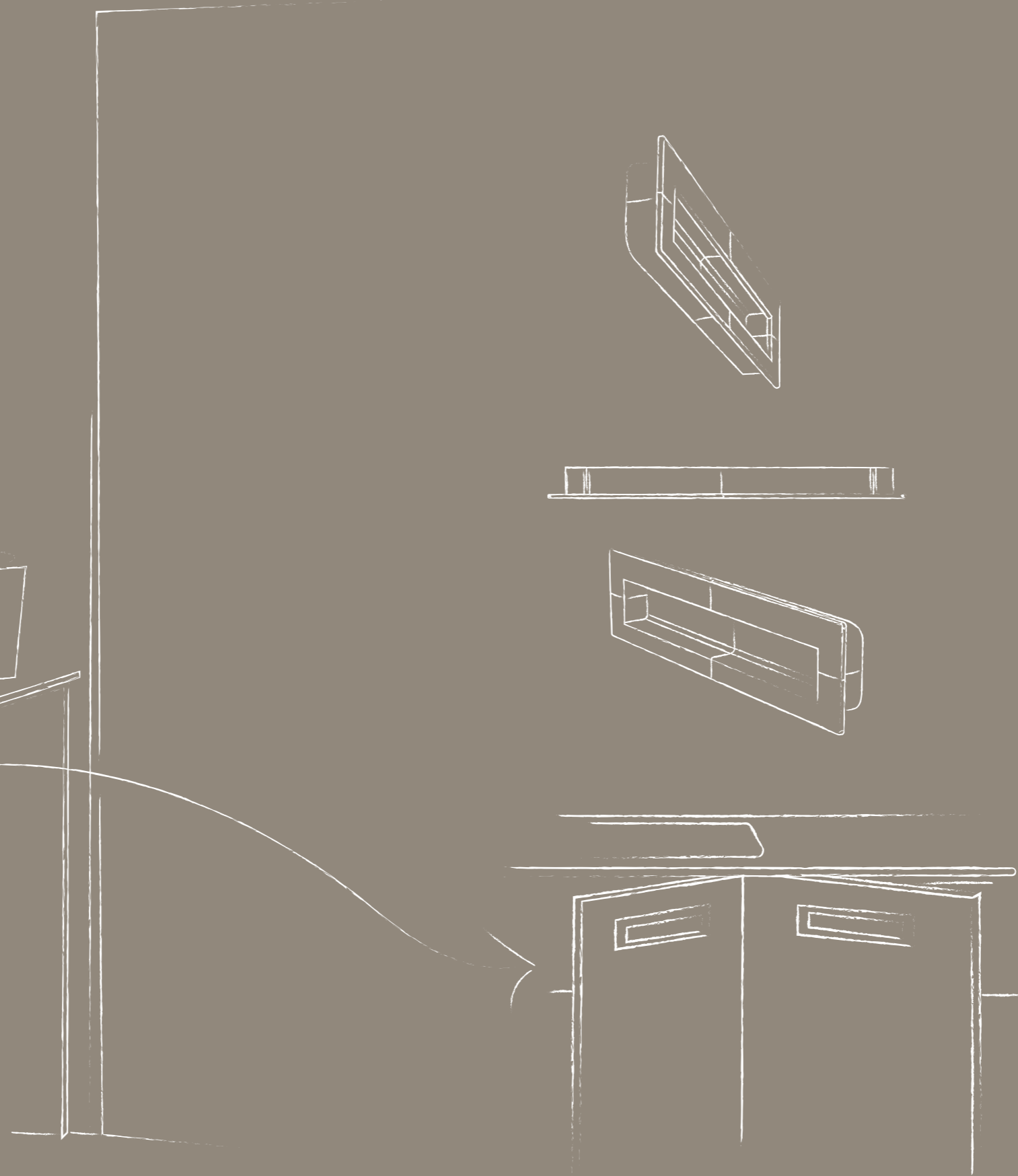
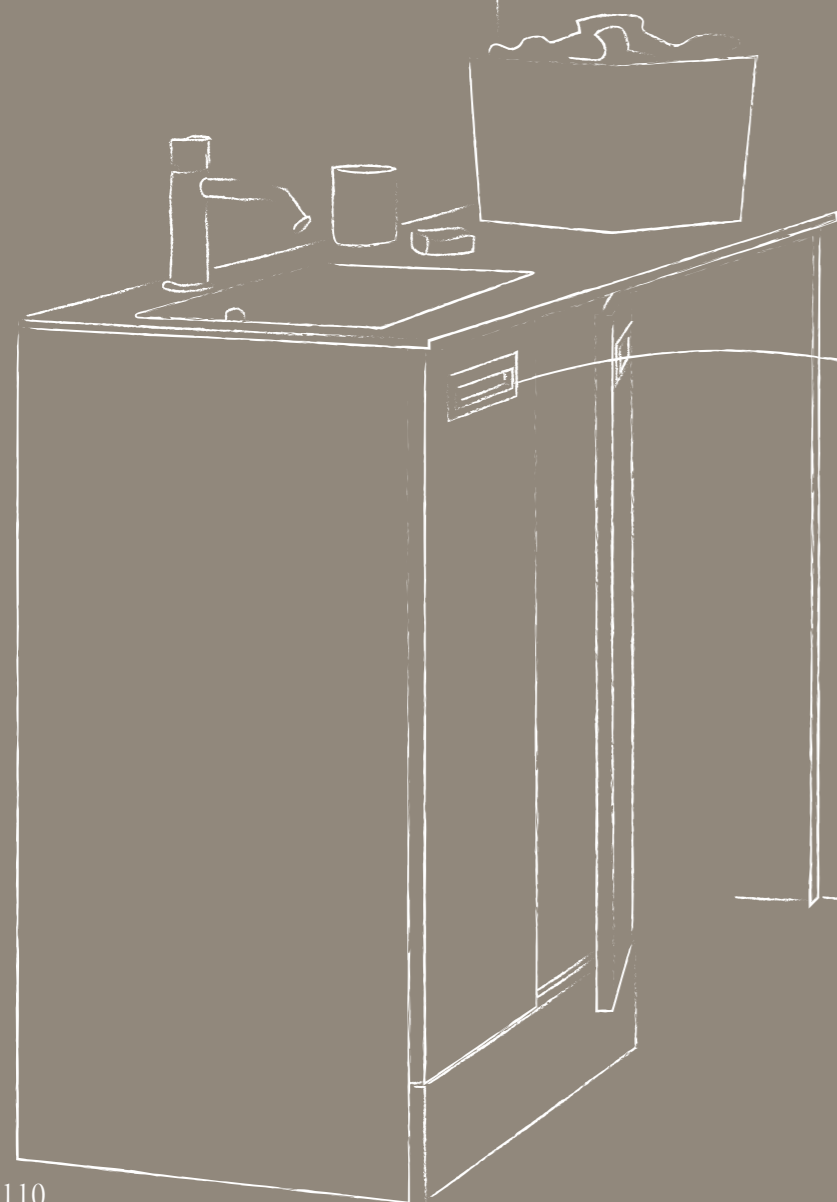
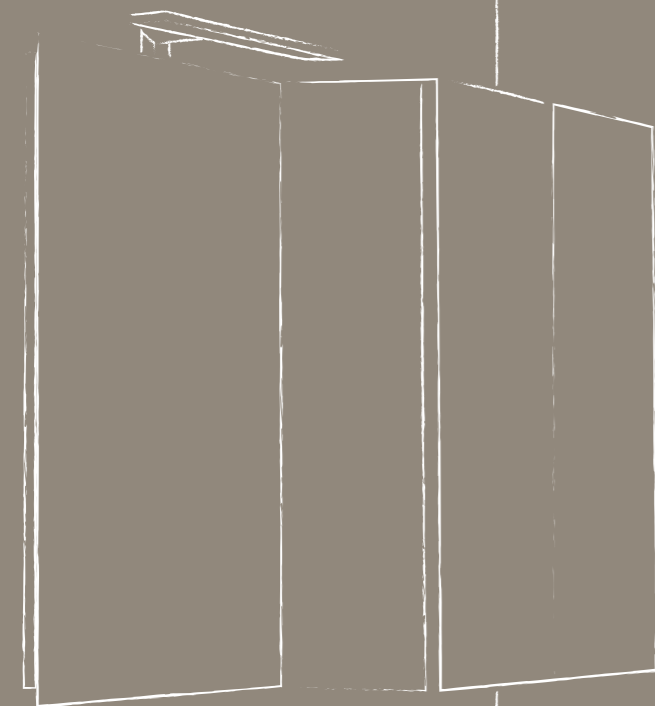

T O T U S

IT

Se c'era una cosa dell'università che spaventava Valentina, era condividere la casa con degli sconosciuti; soprattutto gli spazi intimi, come il bagno. Ma è stata fortunata: ha incontrato tre ragazze della sua età pronte a collaborare e una casa perfetta, dotata di un piccolo e curato bagno lavanderia per gestire le pulizie.

Ci pensa mentre guarda Sofia che apre tutti gli sportelli. Sofia è disordinata ma si dà da fare. "Posso fare la lavatrice al volo? Che poi torno a studiare", chiede Valentina. "Hai visto il detersivo per i pavimenti? L'avevo messo qui", risponde Sofia, "Comunque sì, fai! fai! C'entriamo tutt'e due".

Valentina si avvicina e in un attimo tira fuori il detersivo dallo sportello. "Ce l'avevi davanti agli occhi! Sempre così, tu. Cosa faresti senza di me?".

ENG

If there was one thing about university that scared Valentina, it was sharing a house with strangers; especially intimate spaces, such as the bathroom. But she was lucky: she met three girls her age ready to collaborate and a perfect house, equipped with a small and well-kept laundry bathroom to manage the cleaning.

She thinks about it as she watches Sofia open all the doors. Sofia is messy but she works hard. "Can I do the washing machine on the fly? Then I'll go back to studying," asks Valentina. "Have you seen the floor cleaner? I put it here", replies Sofia, "Anyway, yes, do it! you do! We both fit in here."

Valentina approaches and in an instant takes the detergent out of the door. "You had it right before your eyes! Always like this, you. What would you do without me?".

1

Composizione
Composition

TOTUS



TOTUS

—
3 m² 1:50

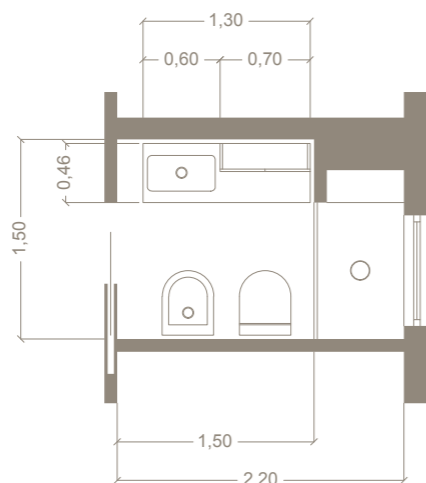

IT

Totus rappresenta la lavanderia contemporanea. Immaginatela come un mobile pieno di risorse per ogni tipo d'uso, l'incarnazione della parola "tuttofare". Può essere molto grande, con una profondità massima di 70 cm, ma anche piccola, con una profondità minima di 46 cm.

Al suo interno trovate cesti, grucce, ripiani, portabiancheria, contenitori, mensole e assi da stiro. Dispone anche di mobili contenitore per la lavatrice e l'asciugatrice. Come tutti i bagni Xilon, anche qui i lavabi sono protagonisti, infatti utilizza sia lavabi in ocritech sia i lavabi in ceramica Nanco 60x60 SIL[®], anche con la doppia profondità di Ghost.

Infine, il mobile è disponibile in tutte le finiture, perché Totus rappresenta la lavanderia totale, da tenere in bella vista.

ENG

Totus represents the contemporary laundry. Imagine it as a piece of furniture full of resources for every type of use, the embodiment of the word "all-rounder". It can be very large, with a maximum depth of 70 cm, but also small, with a minimum depth of 46 cm.

Within you'll find baskets, hangers, shelves, laundry baskets, containers, shelving units and ironing boards. It also features storage units for the washing machine and dryer. Like all Xilon bathrooms, here too the washbasins are protagonists, in fact it uses both Ocritech washbasins and Nanco 60x60 SIL[®] ceramic washbasins, also with the double depth of Ghost.

Lastly, the piece of furniture is available in all finishes, because Totus represents the total laundry, to be kept in plain sight.



2

Composizione
Composition

TOTUS



3
Composizione
Composition
TOTUS



4
Composizione
Composition
TOTUS



5
Composizione
Composition
TOTUS



6

Composizione
Composition

TOTUS



**COLORI
DISPONIBILI**

**COLORS
AVAILABLE**

TUNDRA Opaco Matt Lucido Glossy cod. 01TN cod. 02TN	CAPPUCCINO Opaco Matt Lucido Glossy cod. 01CU cod. 02CU	BIANCO Opaco Matt Lucido Glossy cod. 01BO cod. 02BO
ROSA HIMALAYA Opaco Matt Lucido Glossy cod. 01RH cod. 02RH	CORDA Opaco Matt Lucido Glossy cod. 01CD cod. 02CD	SALVIA Opaco Matt Lucido Glossy cod. 01SV cod. 02SV
BALTICO Opaco Matt Lucido Glossy cod. 01BT cod. 02BT	BURRO Opaco Matt Lucido Glossy cod. 01BR cod. 02BR	VERDE Opaco Matt Lucido Glossy cod. 01VE cod. 02VE
PRUGNA Opaco Matt Lucido Glossy cod. 01PR cod. 02PR	MENTA Opaco Matt Lucido Glossy cod. 01MN cod. 02MN	ZUCCA Opaco Matt Lucido Glossy cod. 01ZC cod. 02ZC
CIOCCOLATO Opaco Matt Lucido Glossy cod. 01CT cod. 02CT	SENAPE Opaco Matt Lucido Glossy cod. 01SN cod. 02SN	TURCHESE Opaco Matt Lucido Glossy cod. 01TR cod. 02TR
GRIGIO Opaco Matt Lucido Glossy cod. 01GR cod. 02GR	SABBIA Opaco Matt Lucido Glossy cod. 01SB cod. 02SB	
NERO Opaco Matt Lucido Glossy cod. 01NR cod. 02NR	ARANCIO Opaco Matt Lucido Glossy cod. 01AA cod. 02AA	
PIETRA Opaco Matt Lucido Glossy cod. 01PE cod. 02PE	CANAPA Opaco Matt Lucido Glossy cod. 01CN cod. 02CN	
AVIO Opaco Matt Lucido Glossy cod. 01AV cod. 02AV	ARGILLA Opaco Matt Lucido Glossy cod. 01FN cod. 02FN	

IT

Totus permette tante combinazioni, a partire dai lavabi che possono essere in ocritech o in ceramica Nanco 60x60 SIL®.

ENG

Totus allows many combinations, starting from the washbasins which can be either ceramic or ocritech.



IT

Per ogni spazio una soluzione. Totus ha tre profondità: 46, 55 e 65 cm.

ENG

A solution for every space. Totus has three depths: 46, 55 and 70 cm.

**LEGNI
MELAMINICI MELAMINE
WOODS**

BIANCO VERTICALE cod. VT	LARICE IRIS cod. IL	ROVERE ADAMELLO cod. AR	OLMO PERLA cod. PO	ROVERE ROSA cod. RR	ANTRACITE cod. AN
BASIC WHITE cod. BW	OLMO MONTANO cod. MO	QUERCIA BRUCIATO cod. BT	QUERCIA BIANCO cod. QB	CEMENTO cod. CT	

ESSENZA 4.0

ROVERE MORO cod. MR	OLMO GRIGIO cod. GO
-------------------------------	-------------------------------

IT

Le colonne contenitive ospitano gli elettrodomestici più ingombranti, come la lavatrice e l'asciugatrice, possono includere anche dei cassetti o usare dello spazio per appendere i panni.

ENG

The storage columns house the bulkiest appliances, such as the washing machine and the dryer, they can also include drawers or use space to hang clothes.



LE NOSTRE PROPOSTE

OUR PROPOSALS

TOTUS - 1

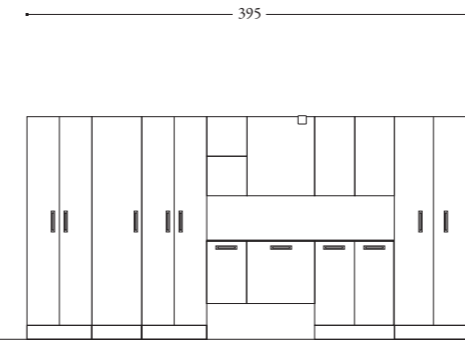

- IT **2255198** Colonna due ante L58xP55xH198 con maniglie ad incasso (2) - **2243AS198** Colonna un'anta L44xP37xH198 con asse da stiro a ribalta con maniglie ad incasso - **253655** Base sospesa L35xP65xH55 un'anta ed un ripiano interno con maniglia ad incasso - **23ML665** Base porta lavabo sospesa con cassettoni L60xP65xH55 con maniglia ad incasso - **2276C87** Base due ante L70xP65xH87 con cesto porta biancheria estraibile a sacco e maniglie ad incasso - **00T651MT** Top in ocritech spessore 10mm P65 (mt 1,65) - **474VAS** Vasca integrata in ocritech L47xP47xH23 - **3MM3520** Contenitore in metallo a giorno L35xP20xH35 - **1360** Specchio a giorno Easy L60xH70 - **729** Lampada mod. Cubo - **22973** Pensile contenitore due ante L70xP37xH70 - **2276198** Colonna inserimento lavatrice/asciugatrice due ante L70xP65xH198
- ENG **2255198** Column two doors W58xP55xH198 with recessed handles (2) - **2243AS198** Column one door W44xP37xH198 with folding ironing board with recessed handles - **253655** Suspended washbasin base W35xP65xH55 one door and one internal shelf with recessed handle - **23ML665** Suspended washbasin base with drawer W60xP65xH55 with recessed handle - **2276C87** Base with two doors W70xP65xH87 with removable laundry basket bag and recessed handles - **00T651MT** Ocritech top thickness 10mm P65 (mt 1,65) - **474VAS** Integrated ocritech basin W47xP47xH23 - **3MM3520** Open metal container W35xP20xH35 - **1360** Open mirror Easy W60xH70 - **729** Lamp mod. Cubo - **22973** Container wall unit two doors W70xP37xH70 - **2276198** Washer/dryer insertion column two doors W70xP65xH198

TOTUS - 2

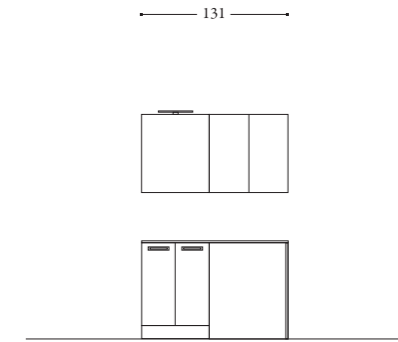

- IT **2240T134** Totus monoblocco L131xP46xH88 con base sottolavabo 2 ante e vano lavatrice a giorno - **1360** Specchio a giorno Easy L60xH70 - **737** Lampada mod. Diamond L45 - **22972** Pensile due ante L70xP22xH70
- ENG **2240T134** Totus monobloc W131xP46xH88 with recessed washbasin base 2 doors and open washing machine compartment - **1360** Open mirror Easy W60xH70 - **737** Lamp mod. Diamond L45 - **22972** Wall unit two doors W70xP22xH70

TOTUS - 3

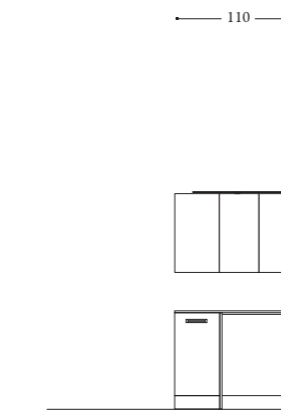

- IT **2240T115** Totus monoblocco L110xP55xH88 con base sottolavabo sospesa un'anta e vano lavatrice a giorno - **229S402** Specchio pensile contenitore L40xP22xH70 un'anta - **229S72** Specchio pensile contenitore L70xP22xH70 con due ante - **737** Lampada mod. Diamond L45
- ENG **2240T115** Totus monobloc L110xP55xH88 with suspended recessed washbasin base one door and open washing machine compartment - **229S402** Hanging container mirror W40xP22xH70 one door - **229S72** Hanging container mirror W70xP22xH70 with two doors - **737** Lamp mod. Diamond L45

TOTUS - 4

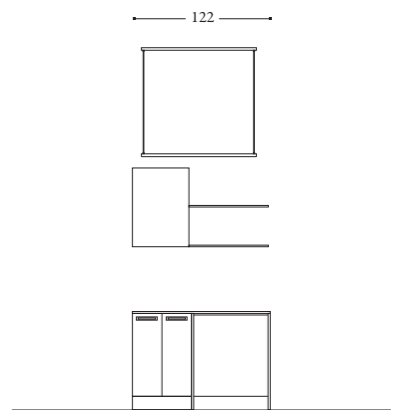

- IT **2240T124** Totus monoblocco L122xP46xH88 con base sottolavabo 2 ante e vano lavatrice a giorno con maniglie ad incasso - **229S502** Specchio pensile contenitore L50xP22xH70 un'anta - **1221** Mensola con fissaggi a scomparsa spessore 18mm (L 0,70cmx2pz) - **738** Lampada ad installazione a soffitto mod. Ambient L80cm
- ENG **2240T124** Totus monobloc L122xP46xH88 with recessed washbasin base 2 doors and open washing machine compartment with recessed handles - **229S502** Hanging container mirror W50xP22xH70 one door - **1221** Shelf with hidden fixings thickness 18mm (L 0,70cmx2pz) - **738** Ceiling installation lamp mod. Ambient L 80 Cm

TOTUS - 5

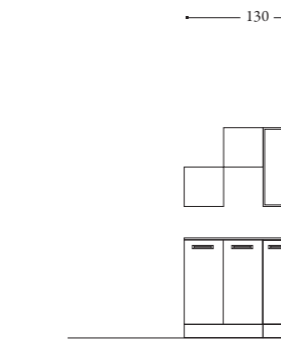

- IT **22ML669** Base sottolavabo L60xP65xH87 due ante - **227687** Base porta lavatrice L70xP65xH87 2 ante - **00T651MT** Top in ocritech spessore 10mm P65 (mt 1,30) - **1SCATOP1** Sagoma per alloggiamento lavabo su top - **866R** Lavabo in ceramica Nanco L60xP60 con SIL rettificato - **1360RSD** Specchio mod. Perimetro L60xH70 con sabbiatura perimetrale retroilluminata, touch e dimmer integrato - **3MM3520** Contenitore in metallo a giorno L35xP20xH35
- ENG **22ML669** Recessed washbasin base W60xP65xH87 two doors - **227687** Washing machine base W70xP65xH87 2 doors - **00T651MT** Ocritech top thickness 10mm P65 (mt 1,30) - **1SCATOP1** Template for washbasin placement on top - **866R** Ceramic washbasin Nanco W60xP60 with grinded SIL - **1360RSD** Mirror mod. Perimetro W60xH70 with backlit perimeter sandblasting, touch and integrated dimmer - **3MM3520** Open metal container W35xP20xH35

TOTUS - 6

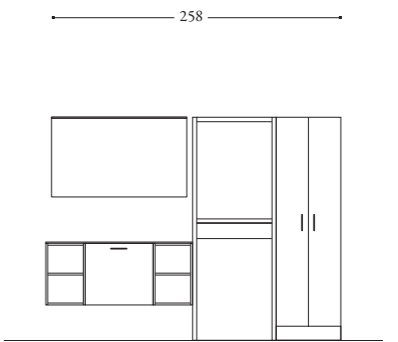

- IT **23ML665** Base sottolavabo sospesa L60xP65xH55 con cassettoni estraibili - **283665** Base a giorno sospesa Jolly L35xP65xH55 - **00T651MT** Top in ocritech spessore 10mm P65 (mt 1,30) - **474VAS** Vasca integrata in ocritech L47xP47xH24 - **3RML12070** Specchiera mod. Road L120xH70 con mensola e led integrati - **LHC65198** Colonna spessorata per inserimento lavatrice/asciugatrice L70xP65xH198 - **LHCT70** Kit cassetto estraibile per colonna spessorata - **2255198** Colonna due ante L58xP55xH198
- ENG **23ML665** Suspended recessed washbasin base W60xP65xH55 with cassettoni estraibili - **283665** Suspended open base Jolly W35xP65xH55 - **00T651MT** Ocritech top thickness 10mm P65 (mt 1,30) - **474VAS** Integrated ocritech basin W47xP47xH24 - **3RML12070** Mirror mod. Road W120xH70 with integrated shelf and LED - **LHC65198** Thickened column for inserting washer/dryer W70xP65xH198 - **LHCT70** Pull-out drawer kit for thickened column - **2255198** Column two doors W58xP55xH198

MENSOLONI

IT

Arredare per esprimere se stesso. Osare, miscelare. Per il suo bagno, Raul ha scelto la collezione Mensoloni, minimale e lineare, con cui coniugare tutta la competenza maturata in questi anni da designer.

Ha deciso di combinare tre materiali: mobile sospeso con finiture in legno, il mensolone in ocritech alto 12 cm come base per il lavabo e per concludere un insolito lavandino in vetro trasparente.

Il risultato è audace ed eclettico, come lui, chi entrerà in casa non lo dimenticherà.

ENG

Furnish to express himself. Dare, mix. For his bathroom, Raul chose the Mensoloni collection, minimal and linear, with which to combine all the expertise gained in these years as a designer.

He decided to combine three materials: suspended cabinet with wooden finishes, the 12 cm high ocritech big shelf as a base for the washbasin and to conclude an unusual sink in transparent glass.

The result is bold and eclectic, like him, whoever enters the house will not forget it.



1

Composizione
Compositon

MENSOLONI



MENSOLONI

6 m² 1:50

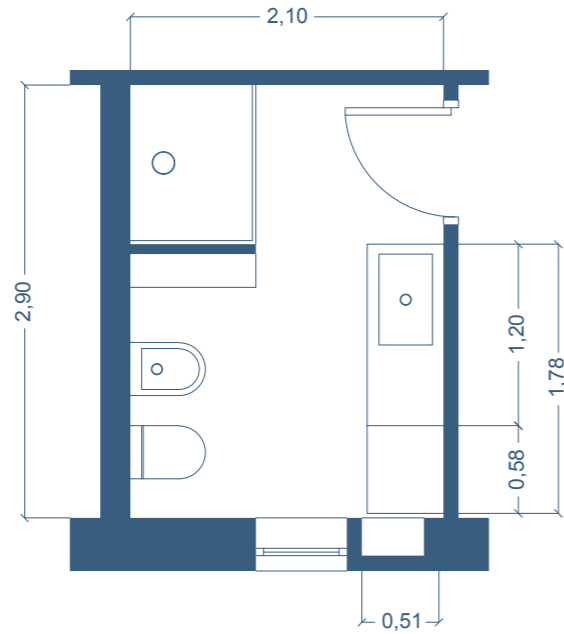

IT

L'apice della personalizzazione al centimetro, una collezione caratterizzata da forme essenziali e materiali che permettono innumerevoli combinazioni.

Il talento di Mensoloni è la capacità di adattarsi ai gusti e agli ambienti. Che siano case, scuole oppure ristoranti di tendenza, il limite è solo la fantasia: molteplici finiture e colori, lavabi in ocritech, in vetro e in ceramica. Apre le porte al gusto e alla personalità di chi la sceglie.

L'arte dell'arredamento incontra l'esperienza del design funzionale. Lo stile minimalista rende la pulizia del mobile facile e veloce; questo è un aspetto da considerare che si dimostra particolarmente vantaggioso nei bagni pubblici. La funzionalità per noi è sempre la prerogativa.

ENG

The pinnacle of customization down to the centimeter, a collection characterized by essential shapes, and materials that allow countless combinations.

Mensoloni's talent is the ability to adapt to tastes and environments. Whether they are homes, schools or trendy restaurants, the limit is only your imagination: multiple finishes and colours, ocritech, glass and ceramic washbasins. It opens the doors to the taste and personality of those who choose it.

The art of furnishing meets the experience of functional design. The minimalist style makes cleaning the furniture quick and easy; this is an aspect to consider that proves particularly advantageous in public toilets. Functionality is always the prerogative for us.



2

Composizione
Composition

MENSOLONI



3
Composizione
Composition

MENSOLONI



4
Composizione
Composition

MENSOLONI



5
Composizione
Composition

MENSOLONI



6

Composizione
Composition

MENSOLONI



7

Composizione
Composition

MENSOLONI



8

Composizione
Composition

MENSOLONI

9

Composizione
Composition

MENSOLONI

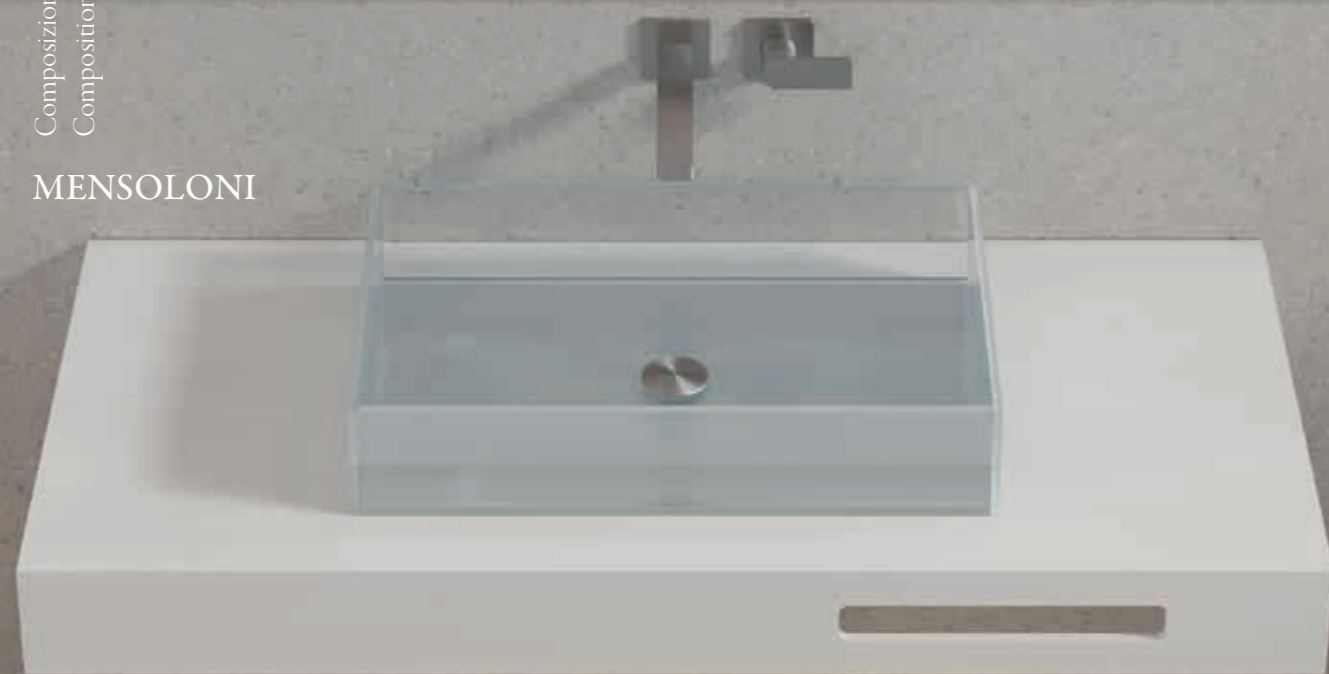

11

Composizione
Composition

MENSOLONI



10

Composizione
Composition

MENSOLONI



12

Composizione
Composition

MENSOLONI





**COLORI
DISPONIBILI**

**COLORS
AVAILABLE**

TUNDRA Opaco Matt Lucido Glossy cod. 01TN cod. 02TN	CAPPUCCINO Opaco Matt Lucido Glossy cod. 01CU cod. 02CU
BALTICO Opaco Matt Lucido Glossy cod. 01BT cod. 02BT	BURRO Opaco Matt Lucido Glossy cod. 01BR cod. 02BR
PRUGNA Opaco Matt Lucido Glossy cod. 01PR cod. 02PR	MENTA Opaco Matt Lucido Glossy cod. 01MN cod. 02MN
GRIGIO Opaco Matt Lucido Glossy cod. 01GR cod. 02GR	SABBIA Opaco Matt Lucido Glossy cod. 01SB cod. 02SB
NERO Opaco Matt Lucido Glossy cod. 01NR cod. 02NR	AVIO Opaco Matt Lucido Glossy cod. 01AV cod. 02AV
BIANCO Opaco Matt Lucido Glossy cod. 01BO cod. 02BO	ROSA HIMALAYA Opaco Matt Lucido Glossy cod. 01RH cod. 02RH
SALVIA Opaco Matt Lucido Glossy cod. 01SV cod. 02SV	VERDE Opaco Matt Lucido Glossy cod. 01VE cod. 02VE
CIOCCOLATO Opaco Matt Lucido Glossy cod. 01CT cod. 02CT	SENAPE Opaco Matt Lucido Glossy cod. 01SN cod. 02SN
CANAPA Opaco Matt Lucido Glossy cod. 01CN cod. 02CN	PIETRA Opaco Matt Lucido Glossy cod. 01PE cod. 02PE
CORDA Opaco Matt Lucido Glossy cod. 01CD cod. 02CD	TURCHESE Opaco Matt Lucido Glossy cod. 01TR cod. 02TR
ZUCCA Opaco Matt Lucido Glossy cod. 01ZC cod. 02ZC	ARANCIO Opaco Matt Lucido Glossy cod. 01AA cod. 02AA
ARGILLA Opaco Matt Lucido Glossy cod. 01FN cod. 02FN	

IT

Bagni dinamici e opportunità di design: potete comporre il mobile con colori e materiali differenti.

ENG

Dynamic bathrooms and design opportunities: you can compose the furniture with different colors and materials.

ESSENZA 4.0

ROVERE MORO cod. MR	OLMO GRIGIO cod. GO
-------------------------------	-------------------------------

**LEGNI
MELAMINICI MELAMINE
WOODS**

BIANCO VERTICALE cod. VT	LARICE IRIS cod. IL	ROVERE ADAMELLO cod. AR	OLMO PERLA cod. PO	ROVERE ROSA cod. RR	ANTRACITE cod. AN
BASIC WHITE cod. BW	OLMO MONTANO cod. MO	QUERCIA BRUCIATO cod. BT	QUERCIA BIANCO cod. QB	CEMENTO cod. CT	



ESSENZA 4.0

ROVERE MORO cod. MR	OLMO GRIGIO cod. GO
-------------------------------	-------------------------------

**LEGNI
MELAMINICI MELAMINE
WOODS**

ROVERE ADAMELLO cod. AR	QUERCIA BRUCIATO cod. BT
-----------------------------------	------------------------------------

IT

Lavorazione della struttura precisa al millimetro, sia in legno sia in ocritech. Per adattarsi a ogni spazio.

ENG

Processing of the structure precise to the millimetre, both in wood and in ocritech. To adapt to any space.

IT

La superficie dove poggia il lavabo sotto è vuota, sfruttiamo lo spazio per aprire dei comodi inserti porta asciugamani.

ENG

The top where the washbasin sits is empty underneath, we take advantage of the space to open some convenient towel holder inserts.



LE NOSTRE PROPOSTE

OUR PROPOSALS

MENSOLONI - 1

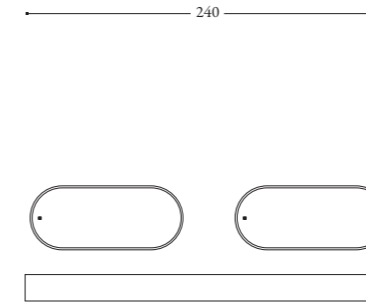

- IT **1MOS1MT** Mensolone in ocritech sciolato H12 cm x P51cm (2,40 m) - **431VAS** Vasca integrata in ocritech L40xP30xH10 - **1STAFMEN** Coppia staffe in metallo per mensoloni - **1216RSD** Specchio ovale L50xH100 reversibile sabbiatura perimetrale retroilluminata, touch e dimmer integrato
- ENG **1MOS1MT** Boxed ocritech big shelf H12cm x D51cm - **431VAS** Integrated ocritech basin W40xP30xH10 - **1STAFMEN** Pair of metal brackets for big shelves - **1216RSD** Oval mirror W50xH100 reversible, backlit perimeter sandblasting, touch and integrated dimmer

MENSOLONI - 2

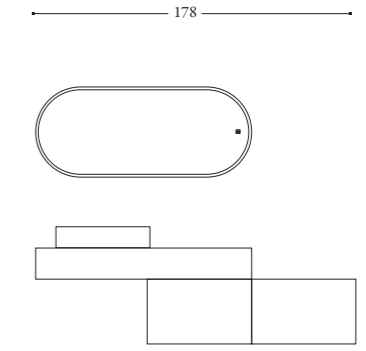

- IT **1MOS1MT** Mensolone in ocritech sciolato H12 cm x P51cm (1,20 m) - **1SCATOP3** Foro feritoia porta asciugamano L30xH4 - **1STAFMEN** Coppia staffe in metallo per mensoloni - **60LVG** Lavabo d'appoggio in vetro L60xP35,5xH12 - **004GT364** Base sospesa un cassettono L58xP51xH36 - **00T511MT** Top in ocritech spessore 10mm P51 - **1216RSD** Specchio ovale L50xH100 reversibile sabbiatura perimetrale retroilluminata, touch e dimmer integrato
- ENG **1MOS1MT** Boxed ocritech big shelf H12cm x D51cm - **1SCATOP3** Slot hole towel holder W30xH4 - **1STAFMEN** Pair of metal brackets for big shelves - **60LVG** Glass countertop washbasin W60xP35,5xH12 - **004GT364** Suspended base one drawer W58xP51xH36 - **P02** Push to open drawer surcharge - **00T511MT** Ocritech top thickness 10mm P51 - **1216RSD** Oval mirror W50xH100 reversible, backlit perimeter sandblasting, touch and integrated dimmer

MENSOLONI - 3



- IT **1MOS1MT** Mensolone in ocritech sciolato H12 cm x P51cm (1,20 m) - **1SCATOP3** Foro feritoia porta asciugamano L30xH4 - **1STAFMEN** Coppia staffe in metallo per mensoloni - **631VAS** Vasca integrata in ocritech L60xP30xH10
- ENG **1MOS1MT** Boxed ocritech big shelf H12cm x D51cm - **1SCATOP3** Slot hole towel holder W30xH4 - **1STAFMEN** Pair of metal brackets for big shelves - **631VAS** Integrated ocritech basin W60xP30xH10

MENSOLONI - 4

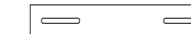

- IT **1MOS1MT** Mensolone in ocritech sciolato H12 cm x P51cm (mt 1,20) - **1SCATOP3** Foro feritoia porta asciugamano L30xH4 - **1STAFMEN** Coppia staffe in metallo per mensoloni - **431VAS** Vasca integrata in ocritech L40xP30xH10
- ENG **1MOS1MT** Boxed ocritech big shelf H12 cm x P51cm (mt 1,20) - **1SCATOP3** Slot hole towel holder W30xH4 - **1STAFMEN** Pair of metal brackets for big shelves - **431VAS** Integrated ocritech basin W40xP30xH10

MENSOLONI - 5



- IT **1MOS1MT** Mensolone in ocritech sciolato H12 cm x P51cm (mt 0,80) - **1STAFMEN** Coppia staffe in metallo per mensoloni - **431VAS** Vasca integrata in ocritech L40xP30xH10
- ENG **1MOS1MT** Boxed ocritech big shelf H12 cm x P51cm (mt 0,80) - **1STAFMEN** Pair of metal brackets for big shelves - **431VAS** Integrated ocritech basin W40xP30xH10 - **502OT** Drain stopper with cap and integrated overflow in ocritech

MENSOLONI - 6

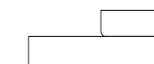

- IT **1MN51MT** Mensolone in legno sciolato H12 cm x P51cm (mt 0,80) - **1STAFMEN** Coppia staffe in metallo per mensoloni - **40LCD** Lavabo in ceramica d'appoggio Ø40xH17
- ENG **1MN51MT** Boxed wooden big shelf H12 cm x P51cm (mt 0,80) - **1STAFMEN** Pair of metal brackets for big shelves - **40LCD** Countertop ceramic washbasin Ø40xH17

MENSOLONI - 7

100

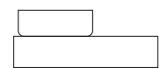

IT IMN51MT Mensolone in legno scatorato H12 cm x P51cm (mt 1) - ISTAFMEN Coppia staffe in metallo per mensoloni - 40LCD Lavabo in ceramica d'appoggio Ø40xH17

ENG IMN51MT Boxed wooden big shelf H12 cm x P51cm (mt 1) - ISTAFMEN Pair of metal brackets for big shelves - 40LCD Countertop ceramic washbasin Ø40xH17

MENSOLONI - 8

120



IT IMN51MT Mensolone in legno scatorato H12 cm x P51cm (mt 1,20) - ISTAFMEN Coppia staffe in metallo per mensoloni - 5038LCD Lavabo in ceramica d'appoggio L50xP38xH17

ENG IMN51MT Boxed wooden big shelf H12 cm x P51cm (mt 1,20) - ISTAFMEN Pair of metal brackets for big shelves - 5038LCD Countertop ceramic washbasin W50xP38xH17

MENSOLONI - 9

120

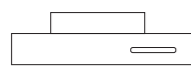

IT IMO51MT Mensolone in ocritech scatorato H12 cm x P51cm (mt 1,20) - ISCATOP3 Foro feritoia porta asciugamano L30xH4 - ISTAFMEN Coppia staffe in metallo per mensoloni (x2) - 60LVG Lavabo d'appoggio in vetro L60xP35,5xH12

ENG IMO51MT Boxed ocritech big shelf H12 cm x P51cm (mt 1,20) - ISCATOP3 Slot hole towel holder W30xH4 - ISTAFMEN Pair of metal brackets for big shelves(x2) - 60LVG Glass countertop washbasin W60xP35,5xH12

MENSOLONI - 10

140

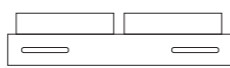

IT IMO51MT Mensolone in ocritech scatorato H12 cm x P51cm (mt 1,40) - ISCATOP3 Foro feritoia porta asciugamano L30xH4 - ISTAFMEN Coppia staffe in metallo per mensoloni - 60LVG Lavabo d'appoggio in vetro L60xP35,5xH12

ENG IMO51MT Boxed ocritech big shelf H12 cm x P51cm (mt 1,40) - ISCATOP3 Slot hole towel holder W30xH4 - ISTAFMEN Pair of metal brackets for big shelves - 60LVG Glass countertop washbasin W60xP35,5xH12

MENSOLONI - 11

100

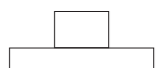

IT IMO51MT Mensolone in ocritech scatorato H12 cm x P51cm (mt 1) - ISTAFMEN Coppia staffe in metallo per mensoloni - 31LVG Lavabo d'appoggio in vetro L31,5xP31,5xH23,5

ENG IMO51MT Boxed ocritech big shelf H12 cm x P51cm (mt 1) - ISTAFMEN Pair of metal brackets for big shelves - 31LVG Glass countertop washbasin W31,5xP31,5xH23,5

MENSOLONI - 11

120

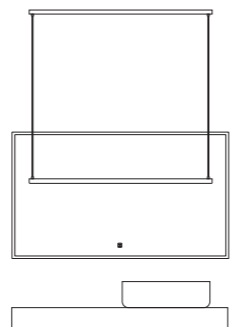

IT IMN51MT Mensolone in ocritech scatorato H12 cm x P51cm (mt 1,20) - ISTAFMEN Coppia staffe in metallo per mensoloni (x2) - 5038LCD Lavabo d'appoggio in ceramica L50xP38xH17 - 0NB51MT Top in melaminico SP18mm P51 (mt 0,58) - I3120RSD Specchio L120xH70 reversibile sabbiatura perimetrale retroilluminata, touch e dimmer integrato

ENG IMN51MT Boxed wooden big shelf H12 cm x P51cm (mt 1,20) - ISTAFMEN Pair of metal brackets for big shelves(x2) - 5038LCD Countertop ceramic washbasin W50xP38xH17 - I3120RSD Reversible mirror W120xH70 backlit perimeter sandblasting, touch and integrated dimmer

“ Il bagno
che amerai usare.”

“The bathroom you
will love to use.”



MONOBLOCCHI

—

MONOBLOCS



1

Composizione
Composition

ALLUMINIUM

ALLUMINIUM

10 m² 1:50

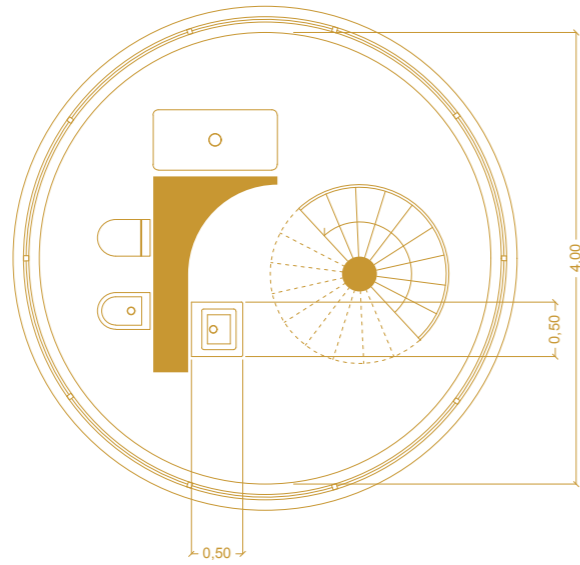

IT

Il nome dice tutto. Un mobile monoblocco in alluminio spesso 3 mm. Una superficie liscia senza saldature e un design che non passa inosservato.

Con quell'anta intagliata sulla superficie e il foro per la maniglia, richiama alla mente ambienti marini e navali. E come la stiva di una nave è un mobile capiente, pronto ad accogliere tutti i vostri oggetti per la pulizia e il benessere. L'alluminio, materiale resistente e duraturo, è l'essenza di questa collezione. Non teme la corrosione provocata dagli agenti atmosferici, poiché Alluminium sfida il tempo. Offre una vasta libertà di abbinamenti perché è disponibile in tutti i colori laccati, con lavabi sia a incasso sia in appoggio a completare il look. Si abbina alle nostre colonne in alluminio e agli specchi con pratiche mensole portaspazzolini da denti.

Il design di Alluminium non si limita agli ambienti marini, ma si inserisce anche in arredamenti alternativi, distinti e alla moda.

ENG

The name says it all. A 3 mm thick monobloc aluminum cabinet. A smooth surface without welding and a design that doesn't go unnoticed. With that door carved into the surface and the hole for the handle it brings to mind marine and naval environments. And like the hold of a ship it's a capacious piece of furniture, ready to accommodate all your objects for cleaning and well-being. Aluminum, a resistant and long-lasting material, is the essence of this collection. It doesn't fear corrosion caused by atmospheric agents, as Alluminium defies time. It offers a vast freedom of combinations because it's available in all lacquered colours, with both recessed and countertop washbasins to complete the look. It matches our aluminum columns and mirrors with practical toothbrush holder shelves. The design of Alluminium is not limited to marine environments, but also fits into alternative, distinguished and fashionable furnishings.



2

Composizione
Compositon

ALLUMINIUM

3

Composizione
Composition

ALLUMINIUM



4

Composizione
Composition

ALLUMINIUM



5

Composizione
Composition

ALLUMINIUM





COLORI DISPONIBILI

COLORS AVAILABLE

TUNDRA Opaco Matt cod. 01TN	CAPPUCCINO Opaco Matt cod. 01CU	BIANCO Opaco Matt cod. 0000
ROSA HIMALAYA Opaco Matt cod. 01RH	CORDA Opaco Matt cod. 01CD	SALVIA Opaco Matt cod. 01SV
BALTICO Opaco Matt cod. 01BT	BURRO Opaco Matt cod. 01BR	VERDE Opaco Matt cod. 01VE
PRUGNA Opaco Matt cod. 01PR	MENTA Opaco Matt cod. 01MN	ZUCCA Opaco Matt cod. 01ZC
CIOCCOLATO Opaco Matt cod. 01CT	SENAPE Opaco Matt cod. 01SN	TURCHESE Opaco Matt cod. 01TR
GRIGIO Opaco Matt cod. 01GR	SABBIA Opaco Matt cod. 01SB	
NERO Opaco Matt cod. 01NR	ARANCIO Opaco Matt cod. 01AA	
PIETRA Opaco Matt cod. 01PE	CANAPA Opaco Matt cod. 01CN	
AVIO Opaco Matt cod. 01AV	ARGILLA Opaco Matt cod. 01FN	

IT

Usiamo un metallo navale che rende il mobile ultrasensibile. Alluminium affronta indenne le intemperie, i prodotti chimici e gli urti.

ENG

We use a naval metal that makes the furniture ultra-resistant. Aluminum faces bad weather, chemicals and impacts unscathed

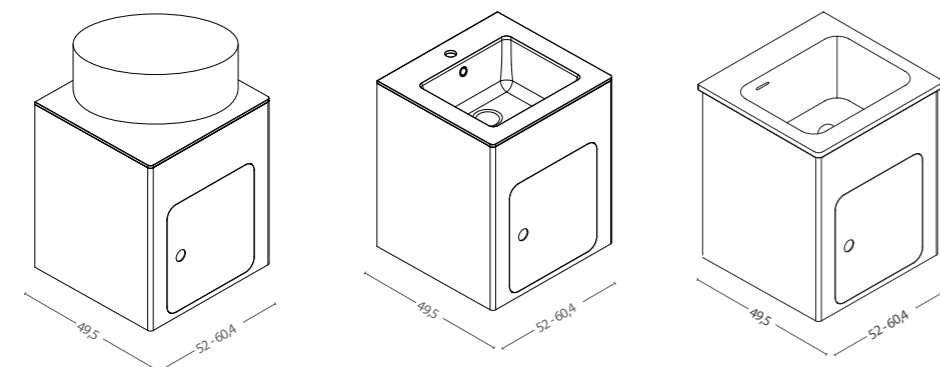

LE NOSTRE PROPOSTE
OUR PROPOSALS

ALLUMINIUM - 1



IT 2164 Alluminium con lavabo in ceramica Nanco No Sil L60xP50xH62

ENG 2164 Alluminium with ceramic washbasin Nanco No Sil W60xP50xH62

ALLUMINIUM - 2



IT 211055 Alluminium con top e lavabo integrato in ocritech L52xP50xH62

ENG 211055 Alluminium with top and integrated washbasin in Ocritech W52xD50xH62

ALLUMINIUM - 3

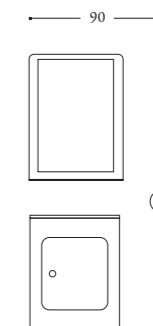

IT 2164 Alluminium con lavabo in ceramica Nanco No Sil L60xP50xH62 - 2151 Specchiera in alluminio con mensola integrata L52xH70xP14 - 731 Lampada Bulbo con staffa per attacco a parete

ENG 2164 Alluminium with ceramic washbasin Nanco No Sil W60xP50xH62 - 2151 Aluminum mirror with integrated shelf W52xH70xP14 - 731 Bulbo lamp with bracket for wall attachment

ALLUMINIUM - 4



IT 21T055 Alluminium con top in ocritech L52xP50xH62 incluso di foro per lavabo d'appoggio - 40LCD Lavabo in ceramica d'appoggio Ø40xH17 - 1216RSD Specchio ovale L50xH100 reversibile sabbiatura perimetrale retroilluminata, touch e dimmer integrato

ENG 21T055 Alluminium with Ocritech top W52xD50xH62 including hole for countertop washbasin - 40LCD Countertop ceramic washbasin Ø40xH17 - 1216RSD Oval mirror W50xH100 reversible, backlit perimeter sandblasting, touch and integrated dimmer

ALLUMINIUM - 5



IT 211055 Alluminium con top e lavabo integrato in ocritech L52xP50xH62 - 1350Specchio a giorno mod. Easy L50xH70

ENG 211055 Alluminium with top and integrated sink in Ocritech W52xD50xH62 - 1350 Open mirror mod. Easy W50xH70

NANCO +

IT

Oggi per Fabio è un giorno di conquista: quello in cui sente di aver superato i suoi limiti. L'obiettivo era raggiungere l'altitudine e la distanza maggiori affrontate nella sua vita.

Fuori il sole si avvia velocemente verso il tramonto, tinge la neve d'arancio e di rosa. Sente di essere esattamente dove vuole essere, in quella intima e accogliente casa di montagna, in quel bagno, con i piedi dolenti e la pelle del viso arrossata, mentre il ghiaccio sulle punte dei bastoncini da trekking cola sul pavimento.

Sfila i guanti, apre il rubinetto e si sciacqua le mani. "Ce l'hai fatta", si ripete. "Ce l'hai fatta".

ENG

Today for Fabio is a day of conquest: the one in which he feels he has overcome his limits. The goal was to reach the greatest altitude and distance he had faced in his life.

Outside the sun is quickly moving towards sunset, it dyes the snow orange and pink. He feels he is exactly where he wants to be, in that intimate and welcoming mountain house, in that bathroom, with sore feet and reddened facial skin, while the ice on the tips of the trekking poles drips onto the floor.

He takes off his gloves, turns on the tap and rinses his hands. "You did it," he repeats to himself. "You did".

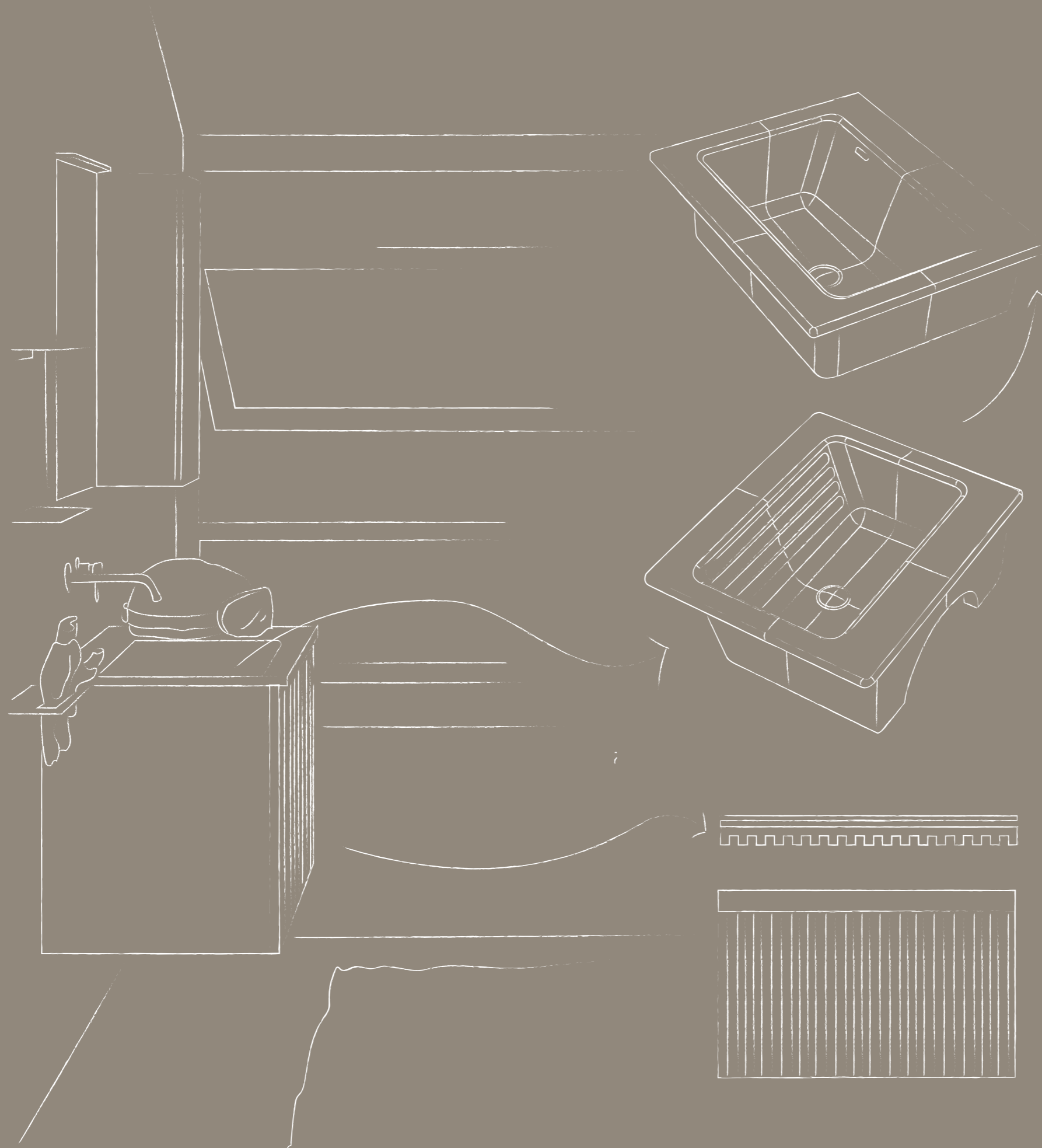



NANCO+

—
5 m² 1:50

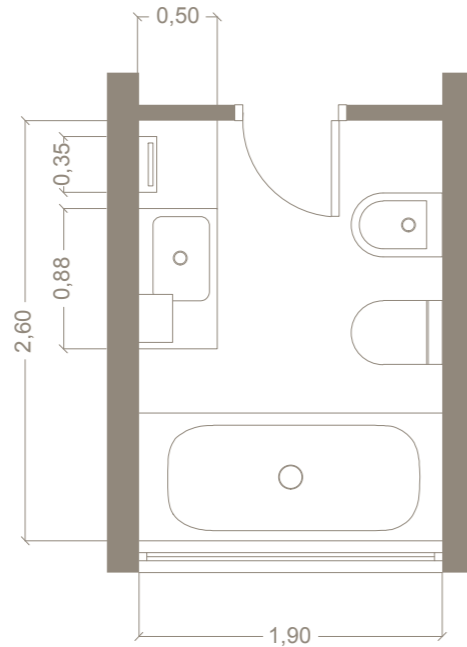

IT

Nanco+ è un'altra espressione dell'estetica della lavanderia che si supera e sconfinata nel design, grazie al basso spessore della ceramica che lo rende elegante come una console. Più versatilità, più stile.

Il mobile monoblocco si adatta con naturalezza ai vostri desideri.

Il lavabo in ceramica Nanco ha un bacino alto 20 cm, con o senza strizzatoio SIL[®]; disponibile nei colori bianco lucido, bianco opaco, nero opaco e sabbia. Colori da abbinare con le finiture in legno, l'Essenza 4.0 oppure con l'ondulata Calàn.

Completano la composizione diverse scelte di pensili e colonnine, che si adeguano al mood e alla disposizione del bagno.

ENG

Nanco+ is another expression of the aesthetics of the laundry that surpasses itself and crosses over into design, thanks to the low thickness of the ceramic which makes it elegant as if it were a console. More versatility, more style.

The monobloc furniture adapts naturally to your desires.

The Nanco ceramic washbasin has a 20 cm high basin, with or without a SIL[®] wringer; available in glossy white, matt white, matt black and sand. Colors to match with the wooden finishes, Essenza 4.0 or with the wavy Calàn.

The composition is completed by various choices of wall units and columns, which adapt to the mood and layout of the bathroom.



2

Composizione
Composition

NANCO+

3

Composizione
Composita

NANCO+





4

Composizione
Composition

NANCO+

5

Composizione
Composition

NANCO+



6
Composizione
Composition
NANCO+



7
Composizione
Composition
NANCO+

8

Composizione
Compositon

NANCO+



**COLORI
DISPONIBILI**

**COLORS
AVAILABLE**

TUNDRA Opaco Matt Lucido Glossy cod. 01TN cod. 02TN	CAPPUCCINO Opaco Matt Lucido Glossy cod. 01CU cod. 02CU	BIANCO Opaco Matt Lucido Glossy cod. 01BO cod. 02BO
ROSA HIMALAYA Opaco Matt Lucido Glossy cod. 01RH cod. 02RH	CORDA Opaco Matt Lucido Glossy cod. 01CD cod. 02CD	SALVIA Opaco Matt Lucido Glossy cod. 01SV cod. 02SV
BALTICO Opaco Matt Lucido Glossy cod. 01BT cod. 02BT	BURRO Opaco Matt Lucido Glossy cod. 01BR cod. 02BR	VERDE Opaco Matt Lucido Glossy cod. 01VE cod. 02VE
PRUGNA Opaco Matt Lucido Glossy cod. 01PR cod. 02PR	MENTA Opaco Matt Lucido Glossy cod. 01MN cod. 02MN	ZUCCA Opaco Matt Lucido Glossy cod. 01ZC cod. 02ZC
CIOCCOLATO Opaco Matt Lucido Glossy cod. 01CT cod. 02CT	SENAPE Opaco Matt Lucido Glossy cod. 01SN cod. 02SN	TURCHESE Opaco Matt Lucido Glossy cod. 01TR cod. 02TR
GRIGIO Opaco Matt Lucido Glossy cod. 01GR cod. 02GR	SABBIA Opaco Matt Lucido Glossy cod. 01SB cod. 02SB	ARANCIO Opaco Matt Lucido Glossy cod. 01AA cod. 02AA
NERO Opaco Matt Lucido Glossy cod. 01NR cod. 02NR	CANAPA Opaco Matt Lucido Glossy cod. 01CN cod. 02CN	PIETRA Opaco Matt Lucido Glossy cod. 01PE cod. 02PE
AVIO Opaco Matt Lucido Glossy cod. 01AV cod. 02AV	ARGILLA Opaco Matt Lucido Glossy cod. 01FN cod. 02FN	

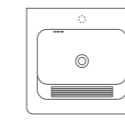

50x50 SIL

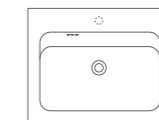

60x50

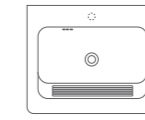

60x50 SIL

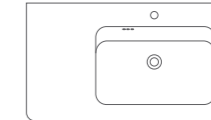

88x50

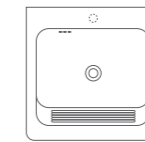

60x60 SIL



**LEGNI
MELAMINICI** **MELAMINE
WOODS**

BIANCO VERTICAL



cod. VT

LARICE IRIS



cod. IL

BASIC WHITE

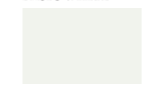

cod. BO

OLMO MONTANO

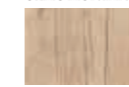

cod. MO

ROVERE ADAMELLO



cod. AR

OLMO PERLA



cod. PO

**QUERCIA
BRUCIATO**



cod. BT

**QUERCIA
CHIARO**



cod. BQ

ROVERE ROSA



cod. RR

ANTRACITE



cod. AM

CEMENTO



cod. CT

ESSENZA 4.0

ROVERE MORO



cod. MR

OLMO GRIGIO



cod. GO

IT

Abbiamo appreso le più raffinate tecniche di lavorazione del legno. L'affascinante finitura in Càlan è il risultato di esperienza e ricerca.

ENG

We have learned the most refined wood processing techniques. The fascinating Càlan finish is the result of experience and research.

IT

Nanco+ è l'evoluzione del classico lavatoio da lavanderia: ne mantiene l'essenza, tuttavia la forma richiama le console a incasso dei bagni moderni.

ENG

Nanco+ is the evolution of the classic laundry sink: it maintains its essence, however the shape recalls the recessed consoles of modern bathrooms.



IT

La maniglia zigrinata rafforza lo stile della collezione, un ulteriore dettaglio che rende il design più raffinato.

ENG

The knurled handle reinforces the style of the collection, a further detail that makes the design more refined.



LE NOSTRE PROPOSTE

OUR PROPOSALS

NANCO - 1

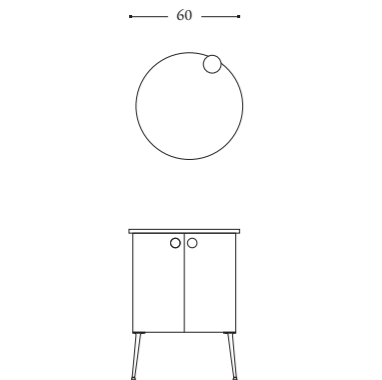

IT 23365 Nanco+ monoblocco sospeso due ante L60xP50xH57 con lavabo in ceramica No SIL - 1214 Specchio mod. Diametro Ø60 - 728 Lampada mod. Point Ø10 - 270P Piedino registrabile in metallo H27 (x2)

ENG 23365 Nanco+ monoblocco sospeso two doors W60xP50xH57 with lavabo in ceramica No SIL - 1214 Mirror mod. Diameter Ø60 - 728 Lamp mod. Point Ø10 - 270P Adjustable metal foot H27 (x2)

NANCO - 2

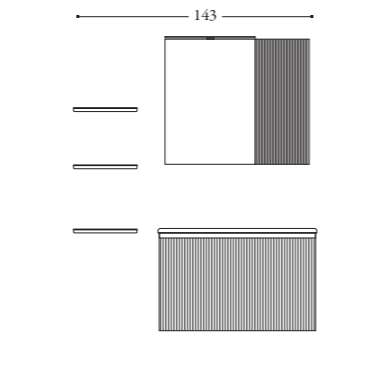

IT 22285 Nanco+ monoblocco sospeso con cassettone L88xP50xH57 con lavabo in ceramica bacino decentrato No SIL - 1350 Specchio a giorno mod. Easy L50xH70 - 730 Lampada mod. Stealth L50 - 22932 Pensile L35xP22xH70 - 3RM35 Mensola in alluminio L35 - 3RPS35 Mensola portasalviette in alluminio L35

ENG 22285 Nanco+ suspended monobloc with drawer W88xD50xH57 with ceramic washbasin decentralized basin No SIL - 1350 Open mirror mod. Easy W50xH70 - 730 Lamp mod. Stealth L50 - 22932 Wall unit W35xD22xH70 - 3RM35 Aluminum shelf L35 - 3RPS35 Aluminum towel shelf L35

NANCO - 3

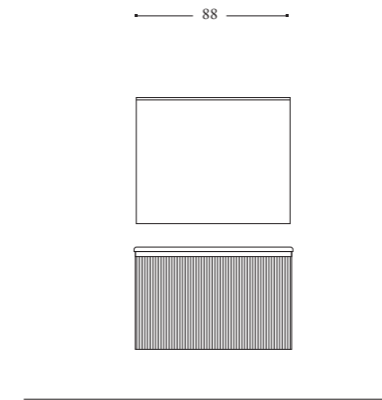

IT 22285 Nanco+ monoblocco sospeso con cassettone L88xP50xH57 con lavabo in ceramica bacino decentrato No SIL - 3RML9070 Specchiera in alluminio Road L90xH70xP12 con led e mensola integrata

ENG 22285 Nanco+ suspended monobloc with drawer W88xD50xH57 with ceramic washbasin decentralized basin No SIL - 3RML9070 Road aluminum mirror W90xH70xP12 with LED and integrated shelf

NANCO - 5

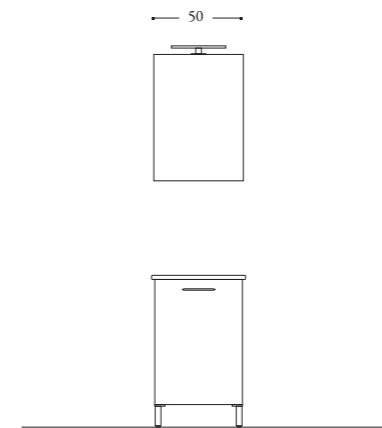

IT 22455 Nanco+ monoblocco con piedini L50xP50xH84 completo di lavabo in ceramica SIL - 229S51 Specchio pensile contenitore L50xP15xH70 - 718 Lampada mod. Luna 30

ENG 22455 Nanco+ monobloc with feet W50xD50xH84 complete with SIL ceramic washbasin - 229S51 Hanging container mirror W50xP15xH70 - 718 Lamp mod. Luna 30

NANCO - 7

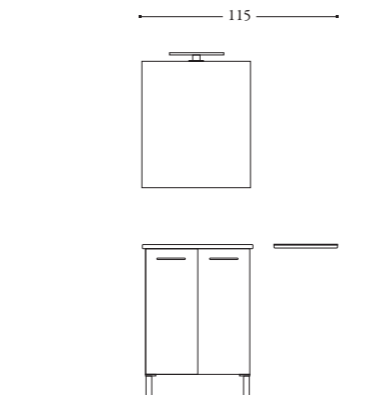

IT 22466 Nanco+ monoblocco con piedini L60xP60xH84 completo di lavabo in ceramica SIL - 229S61 Specchio pensile contenitore L58xP15xH70 - 719 Lampada mod. Luna L45cm - 3RPS35 Mensola portasalviette in alluminio L35

ENG 22466 Nanco+ monobloc with feet W60xD60xH84 complete with SIL ceramic washbasin - 229S61 Hanging container mirror W58xP15xH70 - 719 Lamp mod. Luna L45cm - 3RPS35 Aluminum towel shelf L35

NANCO - 4

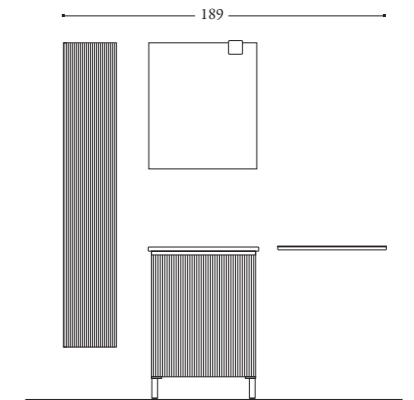

IT 23465 Nanco+ monoblocco con piedini L60xP50xH84 completo di lavabo in ceramica NO SIL - 1360 Specchio a giorno mod. Easy L60xH70 - 729 Lampada mod. Cubo - 1423 Colonna sospesa un'anta L29xP23xH169 - 3RPS60SX Mensola portasalviette in alluminio L60xP12

ENG 23465 Nanco+ monobloc with feet W60xD50xH84 complete with NO SIL ceramic washbasin - 1360 Open mirror mod. Easy W60xH70 - 729 Lamp mod. Cubo - 1423 Suspended column one door W29xP23xH169 - 3RPS60SX Aluminum towel shelf W60xP12

NANCO - 6

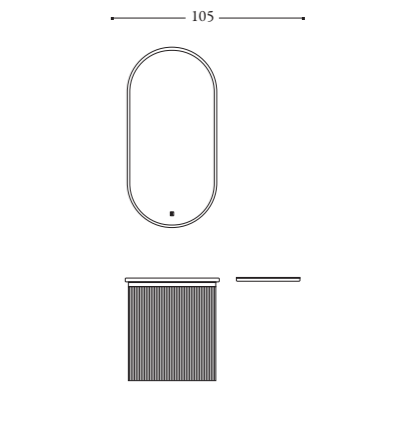

IT 22355 Nanco+ monoblocco sospeso L50xP50xH57 completo di lavabo in ceramica SIL - 1216RSD Specchio ovale L50xH100 reversibile sabbatura perimetrale retroilluminata, touch e dimmer integrato - 3RPS35 Mensola portasalviette in alluminio L35

ENG 22355 Nanco+ suspended monobloc W50xD50xH57 complete with SIL ceramic washbasin - 1216RSD Oval mirror W50xH100 reversible, backlit perimeter sandblasting, touch and integrated dimmer - 3RPS35 Aluminum towel shelf L35

NANCO - 8

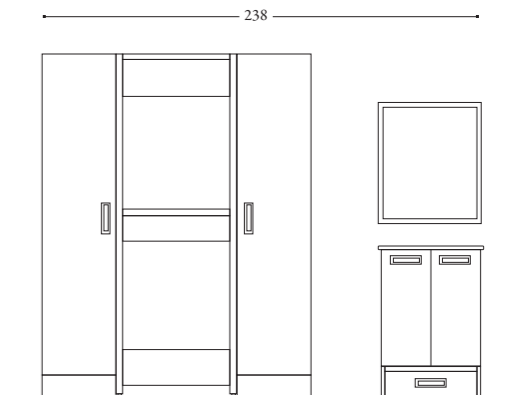

IT 23065 Nanco+ monoblocco con pedana L60xP50xH88 completo di lavabo in ceramica NO SIL con maniglie ad incasso - 3SC50 Specchio mod. Skema con cornice in alluminio L50xH70 - LHCS5198 Colonna spessorata per inserimento lavatrice L70xP55xH198 - LHCT70 Kit cassetto estraibile per colonna spessorata - 2243AS198 Colonna con asse da tiro a ribalta L44xP37xH198 con maniglia ad incasso - 2243198 Colonna con un'anta L44xP37xH198 con maniglia ad incasso (2)

ENG 23065 Nanco+ monobloc with platform W60xD50xH88 complete with ceramic sink NO SIL with recessed handles - 3SC50 Mirror mod. Skema with aluminum frame W50xH70 - LHCS5198 Thickened column for inserting washing machine W70xD55xH198 - LHCT70 Pull-out drawer kit for thickened column - 2243AS198 Column with folding ironing board W44xD37xH198 with recessed handle - 2243198 Column with one door W44xP37xH198 with recessed handle (2)

GHOST®

IT

“Il lavabo dalla doppia anima”, gliel’hanno descritto così, perché contiene un piano che lo divide in due profondità. Si è sentito proprio in questo modo quando è rientrato per la prima volta in questa casa, la casa della nonna. Non aveva mai pensato che un giorno sarebbe venuto a vivere qui, tra le vie del centro storico e dell’infanzia. Questa casa... anche se ha cambiato tante cose, costruito un nuovo bagno, qui vede due opportunità: i legami rassicuranti del passato e i cambiamenti di una nuova vita.

ENG

“The sink with a double soul”, they described it to him this way, because it contains a surface that divides it into two depths. He felt exactly this way when he first returned to this house, his grandmother’s house. He had never thought that one day he would come to live here, among the streets of the historic center and of childhood. This house... even if he has changed many things, built a new bathroom, here he sees two opportunities: the reassuring bonds of the past and the changes of a new life.

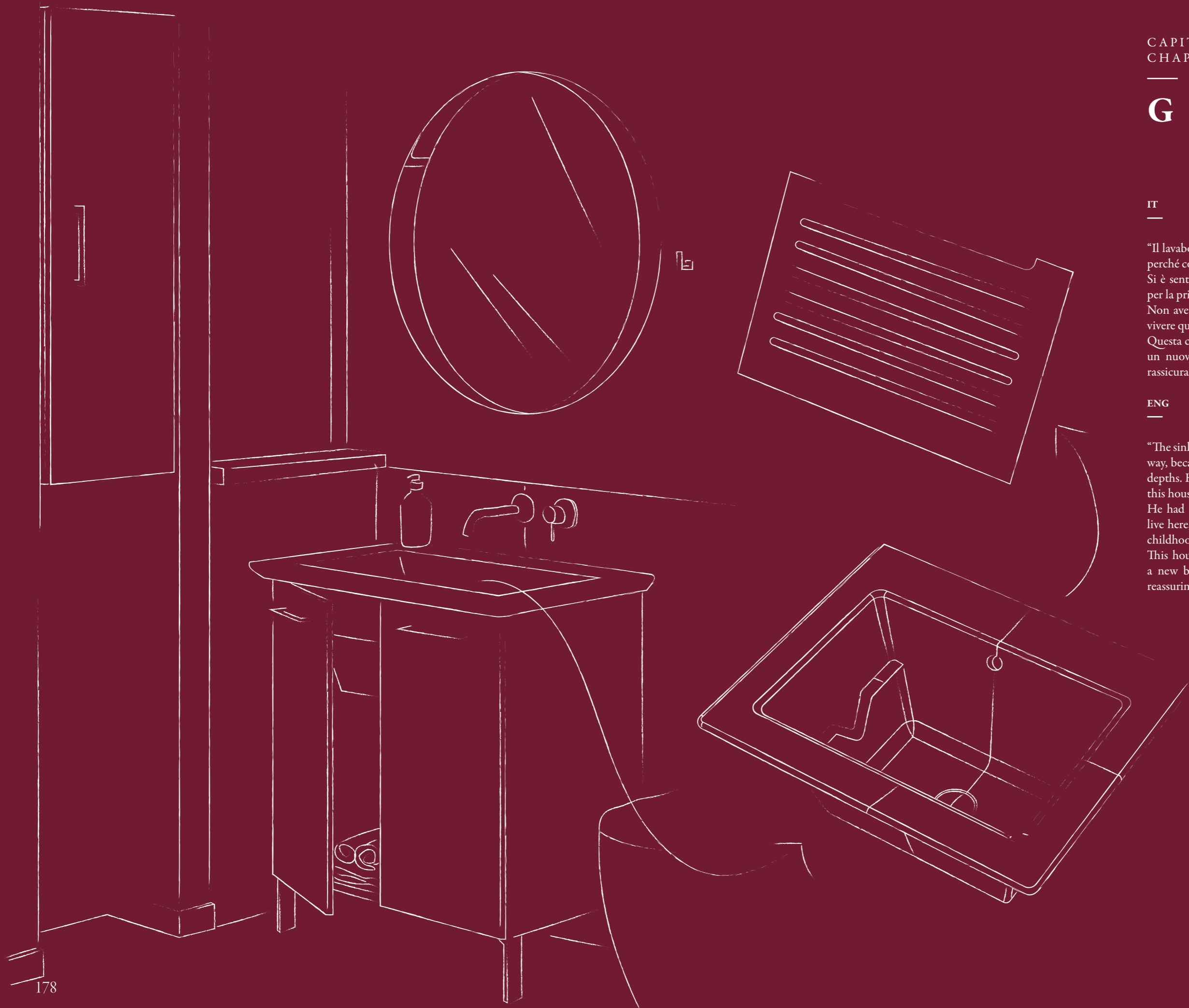

1

Composizione
Compositon

GHOST



GHOST

—
2 m² 1:50

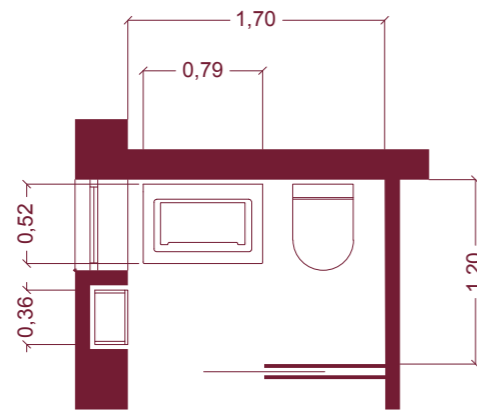

IT

Vi presentiamo Ghost, il lavabo in ceramica con doppia profondità 14+14 cm che apre lo spazio a nuove prospettive pratiche. Per noi è innanzitutto due cose: funzionalità e benessere.

Il piano centrale in ocritech, che nasconde la piletta, permette di gestire comodamente l'altezza del bacino; potete rimuoverlo per accedere a una vasca alta 28 cm e usarlo come strizzatoio. Una capienza che fa la differenza e si adatta con eleganza al bagno.

Offre un'ampia gamma di scelte e dimensioni, che mutano con agilità in base all'uso che dovete fare del bagno e allo spazio disponibile.

Avete trovato l'alleato pratico e affidabile per la vostra routine quotidiana.

ENG

We present Ghost, the ceramic washbasin with double depth 14+14 cm that opens space for new practical perspectives. For us it is first and foremost two things: functionality and well-being.

The central Ocritech top, which hides the drain, allows you to comfortably manage the height of the basin; you can remove it to access a 28 cm high basin and use it as a wringer. A capacity that makes the difference and adapts elegantly to the bathroom.

It offers a wide range of choices and sizes, which change easily based on the use you have of the bathroom and on the space available.

You've found the practical and reliable ally for your daily routine.



2

Composizione
Compositon

GHOST



3

Composizione
Compositon

GHOST



4

Composizione
Composition

GHOST



5

Composizione
Composition

GHOST



COLORI DISPONIBILI

COLORS AVAILABLE

TUNDRA Opaco Matt Lucido Glossy cod. 01TN cod. 02TN	CAPPUCCINO Opaco Matt Lucido Glossy cod. 01CU cod. 02CU	BIANCO Opaco Matt Lucido Glossy cod. 01BO cod. 02BO	ROSA HIMALAYA Opaco Matt Lucido Glossy cod. 01RH cod. 02RH	CORDA Opaco Matt Lucido Glossy cod. 01CD cod. 02CD
BALTICO Opaco Matt Lucido Glossy cod. 01BT cod. 02BT	BURRO Opaco Matt Lucido Glossy cod. 01BR cod. 02BR	SALVIA Opaco Matt Lucido Glossy cod. 01SV cod. 02SV	VERDE Opaco Matt Lucido Glossy cod. 01VE cod. 02VE	ZUCCA Opaco Matt Lucido Glossy cod. 01ZC cod. 02ZC
PRUGNA Opaco Matt Lucido Glossy cod. 01PR cod. 02PR	MENTA Opaco Matt Lucido Glossy cod. 01MN cod. 02MN	TURCHESE Opaco Matt Lucido Glossy cod. 01TR cod. 02TR	CIOCCOLATO Opaco Matt Lucido Glossy cod. 01CT cod. 02CT	SENAPE Opaco Matt Lucido Glossy cod. 01SN cod. 02SN
GRIGIO Opaco Matt Lucido Glossy cod. 01GR cod. 02GR	SABBIA Opaco Matt Lucido Glossy cod. 01SB cod. 02SB	ARANCIO Opaco Matt Lucido Glossy cod. 01AA cod. 02AA	CANAPA Opaco Matt Lucido Glossy cod. 01CN cod. 02CN	PIETRA Opaco Matt Lucido Glossy cod. 01PE cod. 02PE
NERO Opaco Matt Lucido Glossy cod. 01NR cod. 02NR	AVIO Opaco Matt Lucido Glossy cod. 01AV cod. 02AV	ARGILLA Opaco Matt Lucido Glossy cod. 01FN cod. 02FN		



IT

Il lavabo Ghost può essere montato direttamente sulla parete, per ridurre l'ingombro dei mobili e aprire le porte a ulteriori possibilità di allestimento.

ENG

The Ghost washbasin can be mounted directly on the wall, to reduce the clutter of the furniture and open the doors to further setup possibilities.

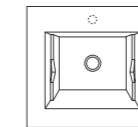

55x52

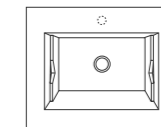

65x52

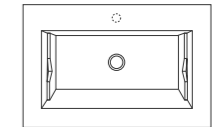

79x52

IT

L'ocritech applicato alla ceramica. Il piano di Ghost esalta la versatilità e duplica le funzioni del lavabo.

ENG

Ocritech applied to ceramics. The Ghost removable top enhances versatility and duplicates the functions of the sink.



LEGNI MELAMINICI

BIANCO VERTICAL



cod. VT

BASIC WHITE

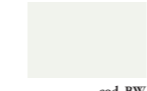

cod. BW

ROVERE ADAMELLO



cod. AR

QUERCIA BRUCIATO

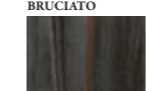

cod. BT

ROVERE ROSA



cod. RR

CEMENTO



cod. CT

ESSENZA 4.0

ROVERE MORO



cod. MR

MELAMINE WOODS

LARICE IRIS



cod. IL

OLMO MONTANO



cod. MO

OLMO PERLA



cod. PO

QUERCIA BIANCO



cod. QB

ANTRACITE



cod. AN

OLMO GRIGIO



cod. GO

IT

Alle opzioni si aggiunge questo nuovo piedino sottile per appoggiare il mobile. Un elemento sottile e minimale, per un accento più ricercato.

ENG

Added to the options is this new thin foot for supporting the furniture. A subtle and minimal element, for a more refined accent.

LE NOSTRE PROPOSTE

OUR PROPOSALS

GHOST - 1

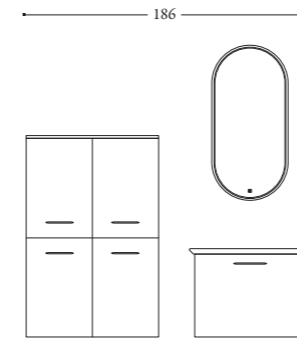

- IT 4GTMB756 Ghost monoblocco sospeso L78xP51xH57 con cassettoni completo di lavabo in ceramica - 1216RSD Specchio ovale L50xH100 reversibile sabbiatura perimetrale retroilluminata, touch e dimmer integrato - 1442 Colonna sospesa L44xP37xH132 con un'anta battente ed un'anta a ribalta con cesto porta biancheria (2)
- ENG 4GTMB756 Ghost suspended monobloc W78xD51xH57 with drawer complete with ceramic sink - 1216RSD Oval mirror W50xH100 reversible, backlit perimeter sandblasting, touch and integrated dimmer - 1442 Suspended column W44xD37xH132 with one hinged door and one folding door with laundry basket (2)

GHOST - 2

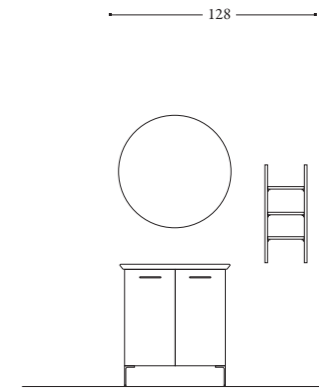

- IT 4GTMB759 Ghost monoblocco con piedini L78xP51xH87 due ante completo di lavabo in ceramica - 1213CM Specchio Ø80 con cornice in metallo nero - 3RUV3070 Pensile a giorno in alluminio L30xP22xH70 con ripiani in vetro fumé
- ENG 4GTMB759 Ghost monobloc with feet W78xD51xH87 two doors complete with ceramic washbasin - 1213CM Ø80 mirror with black metal frame - 3RUV3070 Open wall unit in aluminum W30xD22xH70 with smoked glass shelves

GHOST - 3

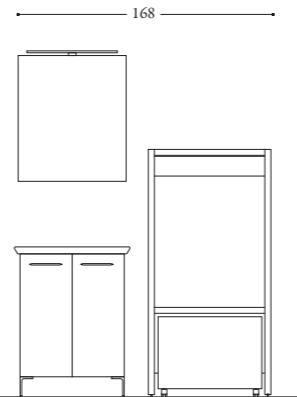

- IT 4GTMB759 Ghost monoblocco con piedini L78xP51xH87 due ante completo di lavabo in ceramica - 1370 Specchio a giorno mod. Easy L70xH50 - 737 Lampada mod. Diamond L45 - LHC55140 Colonna spessorata per inserimento lavatrice L70xP55xH140 - LHCR6040 Contenitore su ruote L60xP52xH44
- ENG 4GTMB759 Ghost monobloc with feet W78xD51xH87 two doors complete with ceramic washbasin - 1370 Open mirror mod. Easy W70xH50 - 738 Lamp mod. Diamond L45 - LHC55140 Thickened column for washing machine insertion W70xP55xH140 - LHCR6040 Container on wheels W60xP52xH44

GHOST - 4

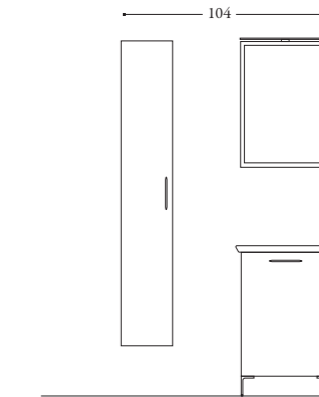

- IT 4GTMB559 Ghost monoblocco con piedini L55xP51xH87 due ante completo di lavabo in ceramica - 35C50 Specchio mod. Skema con cornice in alluminio L50xH70 - 730 Lampada mod. Stealth L 50cm nera - 1423 Colonna sospesa un'anta L29xP22xH169
- ENG 4GTMB559 Ghost monobloc with feet W55xD51xH87 two doors complete with ceramic sink - 35C50 Mirror mod. Skema with aluminum frame W50xH70 - 730 Lamp mod. Stealth L 50cm black - 1423 Suspended column one door W29xP22xH169

GHOST - 5

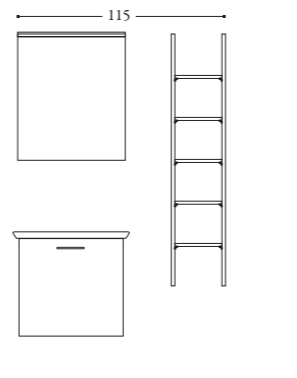

- IT 4GTMB656 Ghost monoblocco sospeso L65xP51xH57 con cassettoni completo di lavabo in ceramica - 3RM6070 Specchiera in alluminio Road L60xH70xP12 con mensola integrata - 732 Lampada mod. Mirror L60 nera - 3RUL30140 Pensile Road con struttura in alluminio L30xP22xH140 con ripiani in legno
- ENG 4GTMB656 Ghost suspended monobloc W65xD51xH57 with drawer complete with ceramic washbasin - 3RM6070 Road aluminum mirror W60xH70xP12 with integrated shelf - 732 Lamp mod. Mirror L60 black - 3RUL30140 Road wall unit with aluminum structure W30xD22xH140 with wooden shelves

GHOST - 6

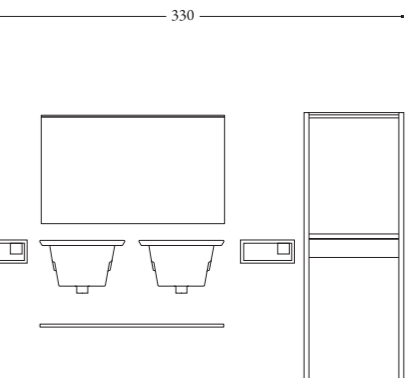

- IT 4GT55 Lavabo in ceramica Ghost W55xP51 (2) - 3RML12070 Specchiera in alluminio Road L120xH70xP12 con mensola integra - 734 Lampada mod. Mirror L120 nera - LHC65198 Colonna spessorata per inserimento lavatrice L70xP65xH198 - LHCT70 Kit cassetto estraibile per colonna spessorata - 1221 Mensola con fissaggi a scomparsa spessore 18m - 3MLOTB35 Mensola multifunzione L35xP15xH15 con ripiano in ocritech (2)
- ENG 4GT55 Ceramic washbasin Ghost W55xP51(2) - 734 Lamp mod. Mirror L120 - 3RML12070 Road aluminum mirror W120xH70xP12 with LED and integrated shelf - LHC65198 Thickened column for washing machine insertion W70xP65xH198 - LHCT70 Removable drawer kit for thickened column - 1221 Shelf with hidden fixings thickness 18m - 3MLOTB35 Multifunctional shelf W35xD15xH15 with shelf and integrated toothbrush holder in ocritech (2)aa

LAVARREDO®

IT

Potrebbe chiamarlo Cowboy, Tornado o Guerriero, di certo, deve aver lottato con il giardino. “Non ti azzardare a entrare in casa conciato così!”, dice agguantando al volo Matteo mentre lui galoppa verso la porta. “Sei da lavare da capo a piedi”. È una giornata calda e soleggiata, perfetta per dargli una sciacquata e togliere tutta quella terra. Matteo sale sulla pedana e si lava mani e braccia. Poi la madre lo spoglia e lo mette tutto intero nel lavabo. “Mamma, dai! Non farmi il solletico!”, troppo tardi, ora ridono entrambi.

ENG

She could call him Cowboy, Tornado or Warrior, for sure, he must have struggled with the garden. “Don’t you dare come into the house in such a state!”, she says, grabbing Matteo on the fly as he gallops towards the door. “You need to be washed from head to toe.” It’s a warm and sunny day, perfect for giving him a rinse and removing all that dirt. Matteo climbs onto the platform and washes his hands and arms. Then his mother undresses him and puts him whole in the sink. “Mom, come on! Don’t tickle me!”, too late, now they’re both laughing.

1

Composizione
Compositon

LAVARREDO



LAVARREDO

3,5 m² 1:50

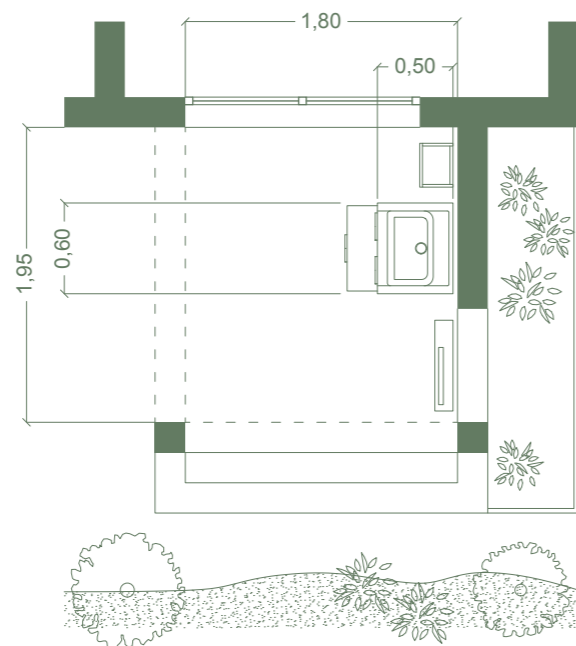

IT

Lavarredo è stata la nostra prova del fuoco. È iniziato tutto qui, nel 2002, con una vasca in ABS metacrilato, per arrivare nel 2004 al primo lavabo inedito in ceramica, declinato in diverse misure. La pioniera del bagno funzionale: è da quel momento che tracciamo la rotta verso nuovi traguardi.

Qui il bagno incontra per la prima volta la lavanderia, un connubio mai sperimentato prima. Il risultato è il bagno funzionale. Con vasche di 4 larghezze - da 50 a 90 cm - e bacini alti 24 cm, Lavarredo ha tutti i comfort di una lavanderia senza rinunciare alle potenzialità estetiche che solo un bagno può offrire. Dai piccoli spazi ai più grandi, ogni dettaglio è stato studiato attentamente per offrire una funzionalità senza eguali.

ENG

Lavarredo was our trial by fire. It all started here, in 2002, with an ABS methacrylate basin, arriving in 2004 at the first new ceramic washbasin, declined in different sizes. The pioneer of the functional bathroom: it's from that moment that we chart the course towards new goals. Here the bathroom meets the laundry for the first time, a combination never experienced before. The result is the functional bathroom. With washbasins of 4 widths - from 50 to 90 cm - and 24 cm high basins, Lavarredo has all the comforts of a laundry room without giving up the aesthetic potential that only a bathroom can offer. From small spaces to larger, every detail has been carefully designed to offer unparalleled functionality.

2

Composizione
Composition

LAVARREDO



3

Composizione
Composition

LAVARREDO



4

Composizione
Composition

LAVARREDO



5

Composizione
Composition

LAVARREDO





6
Composizione
Composition
LAVARREDO



7
Composizione
Composition
LAVARREDO

8

Composizione
Compositum

LAVARREDO



COLORI DISPONIBILI

COLORS AVAILABLE

TUNDRA Opaco Matt / Lucido Glossy cod. 01TN / cod. 02TN	CAPPUCCINO Opaco Matt / Lucido Glossy cod. 01CU / cod. 02CU	BIANCO Opaco Matt / Lucido Glossy cod. 01BO / cod. 02BO	ROSA HIMALAYA Opaco Matt / Lucido Glossy cod. 01RH / cod. 02RH	CORDA Opaco Matt / Lucido Glossy cod. 01CD / cod. 02CD
BALTICO Opaco Matt / Lucido Glossy cod. 01BT / cod. 02BT	BURRO Opaco Matt / Lucido Glossy cod. 01BR / cod. 02BR	SALVIA Opaco Matt / Lucido Glossy cod. 01SV / cod. 02SV	VERDE Opaco Matt / Lucido Glossy cod. 01VE / cod. 02VE	ZUCCA Opaco Matt / Lucido Glossy cod. 01ZC / cod. 02ZC
PRUGNA Opaco Matt / Lucido Glossy cod. 01PR / cod. 02PR	MENTA Opaco Matt / Lucido Glossy cod. 01MN / cod. 02MN	TURCHESE Opaco Matt / Lucido Glossy cod. 01TR / cod. 02TR	CIOCCOLATO Opaco Matt / Lucido Glossy cod. 01CT / cod. 02CT	SENAPE Opaco Matt / Lucido Glossy cod. 01SN / cod. 02SN
GRIGIO Opaco Matt / Lucido Glossy cod. 01GR / cod. 02GR	SABBIA Opaco Matt / Lucido Glossy cod. 01SB / cod. 02SB	ARANCIO Opaco Matt / Lucido Glossy cod. 01AA / cod. 02AA	CANAPA Opaco Matt / Lucido Glossy cod. 01CN / cod. 02CN	PIETRA Opaco Matt / Lucido Glossy cod. 01PE / cod. 02PE
NERO Opaco Matt / Lucido Glossy cod. 01NR / cod. 02NR	AVIO Opaco Matt / Lucido Glossy cod. 01AV / cod. 02AV	ARGILLA Opaco Matt / Lucido Glossy cod. 01FN / cod. 02FN		



IT

Il design di Lavarredo è il frutto di una ricerca progettuale, nel quale si incontrano la lavanderia di una volta e il design dei bagni contemporanei. Il pioniere del bagno funzionale.

ENG

Lavarredo's design is the result of design research, in which the laundry of the past and the design of contemporary bathrooms meet. The pioneer of the functional bathroom.

LEGNI MELAMINICI

MELAMINE WOODS

BIANCO VERTICAL cod. VT	LARICE IRIS cod. IL	ROVERE ADAMELLO cod. AR	OLMO PERLA cod. PO	ROVERE ROSA cod. RR	ANTRACITE cod. AN	ROVERE MORO cod. MR	OLMO GRIGIO cod. GO
BASIC WHITE cod. BW	OLMO MONTANO cod. MO	QUERCIA BRUCIATO cod. BT	QUERCIA BIANCO cod. QB	CEMENTO cod. CT			

ESSENZA 4.0

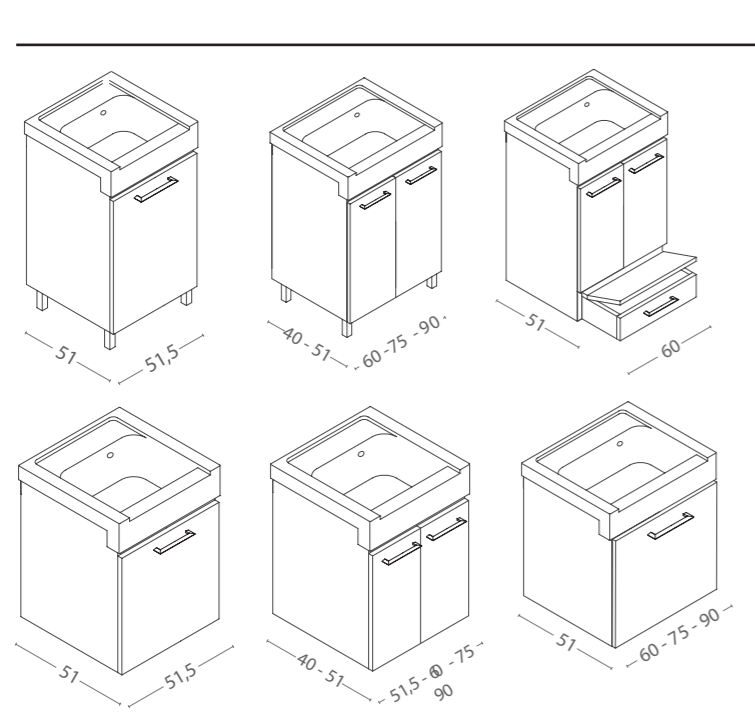

IT

Questa utile pedana estraibile può diventare una superficie su cui appoggiare oggetti all'occorrenza o uno scalino per i bambini, oltre a essere contenitiva.

ENG

This useful pull-out platform can become a surface on which to place objects if necessary or a step for children, in addition to being for storage.



IT

Un design deciso e vasche più profonde della media: 24 cm di altezza. Tutta la praticità di una lavanderia.

ENG

A bold design and deeper than average basins: 24 cm high. All the convenience of a laundry.

IT

Il lavabo in ceramica Lavarredo ha uno spesso bordo anteriore, incassato nel mobile. Pensato per la funzione di lavanderia, in cui capita spesso di appoggiare secchi e contenitori.

ENG

The Lavarredo ceramic washbasin has a thick front edge, recessed into the cabinet. Designed for the laundry function, where buckets and containers are often placed.

IT

Il lavabo Lavarredo può essere montato direttamente sulla parete, per ridurre l'ingombro dei mobili e aprire le porte a ulteriori possibilità di allestimento.

ENG

The Lavarredo washbasin can be mounted directly on the wall, to reduce the clutter of the furniture and open the doors to further setup possibilities.



LE NOSTRE PROPOSTE

OUR PROPOSALS

LAVARREDO - 1

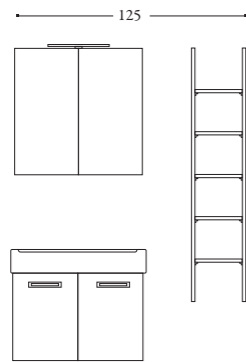

- IT 1474 Lavarredo monoblocco sospeso due ante L75xP40xH62 completo di lavabo in ceramica - 229S71 Specchio pensile contenitore due ante L70xP15xH70 - 737 Lampada mod. Diamond L45cm - 3RUL30140 Pensile a giorno in alluminio L30xP22xH140 con ripiani in legno
- ENG 1474 Lavarredo suspended monobloc washbasin two doors W75xD40xH62 complete with ceramic washbasin - 229S71 Hanging container mirror two doors W70xP15xH70 - 737 Lamp mod. Diamond L45cm - 3RUL30140 Open wall unit in aluminium W30xP22xH140 with wooden shelves

LAVARREDO - 2

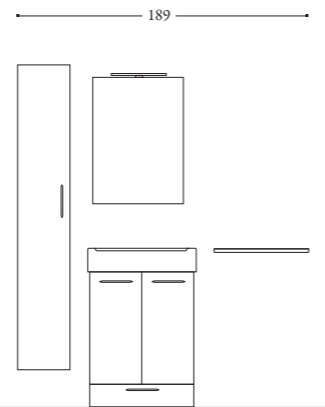

- IT 1565 Lavarredo monoblocco con pedana estraibile e due ante L60xP50xH91 completo di lavabo in ceramica - 229S51 Specchio pensile contenitore L50xP15xH70 - 718 Lampada mod. Luna L30cm - 1423 Colonna sospesa un'anta L29xP22xH169 - 3RPS60DX Mensola portasalviette in alluminio L60xP12
- ENG 1565 Lavarredo monobloc with pull-out platform and two doors W60xD50xH91 complete with ceramic washbasin - 229S51 Hanging container mirror W50xP15xH70 - 718 Lamp mod. Luna L30cm - 1423 Suspended column one door W29xP22xH169 - 3RPS60DX Aluminum towel shelf W60xP12

LAVARREDO - 7

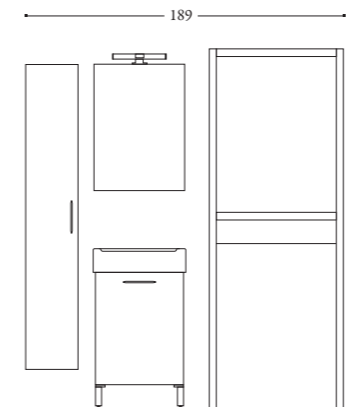

- IT 1255 Lavarredo monoblocco con piedini ed un'anta L50xP50xH87 completo di lavabo in ceramica. - 229S51 Specchio pensile contenitore un'anta L50xP15xH70 - 735 Lampada mod. Roll L30cm - 1423 Colonna sospesa un'anta L29xP22xH169 - LHC55198 Colonna spessorata per inserimento lavatrice/asciugatrice L70xP55xH198 - LHCT70 Kit cassetto estraibile per colonna spessorata
- ENG 1255 Lavarredo monobloc with feet and one door W50xD50xH87 complete with ceramic washbasin. - 229S51 Hanging container mirror one door W50xP15xH70 - 735 Lamp mod. Roll L30cm - 1423 Suspended column one door W29xP22xH169 - LHC55198 Thickened column for inserting washer/dryer W70xP55xH198 - LHCT70 Removable drawer kit for thickened column

LAVARREDO - 8

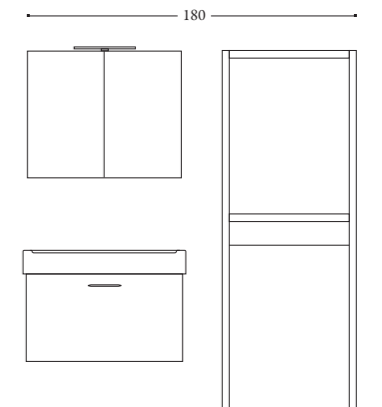

- IT 1695 Lavarredo monoblocco sospeso con cassettoni L90xP50xH62 completo di lavabo in ceramica. - 229S81 Specchio pensile contenitore due ante L85xP15xH70 - 737 Lampada mod. Diamond L45 cm - LHC65198 Colonna spessorata per inserimento lavatrice/asciugatrice L70xP65xH198 - LHCT70 Kit cassetto estraibile per colonna spessorata
- ENG 1695 Lavarredo suspended monobloc with drawer W90xD50xH62 complete with ceramic washbasin. - 229S81 Hanging container mirror two doors W85xP15xH70 - 737 Lamp mod. Diamond L45 cm - LHC65198 Thickened column for inserting washer/dryer W70xP65xH198 - LHCT70 Removable drawer kit for thickened column

LAVARREDO - 3

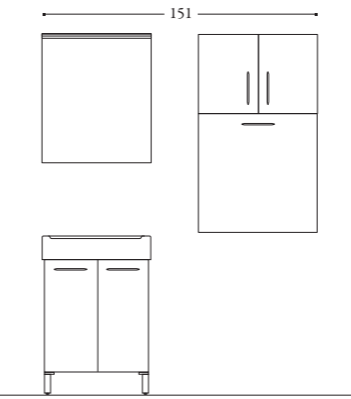

- IT 1265 Lavarredo monoblocco con piedini e due ante L65xP50xH87 completo di lavabo in ceramica - 3RM6070 Specchiera in alluminio Road L60xH70xP12 con mensola integra - 732N Lampada mod. Mirror L60 - 1463 Pensile L66xP37xH110 con due ante superiori ed un'anta inferiore a ribalta con cesto porta biancheria
- ENG 1265 Lavarredo monoblock with feet and two doors W65xP50xH87 complete with ceramic washbasin - 3RM6070 Road aluminum mirror W60xH70xP12 with integrated shelf - 732N Lamp mod. Mirror L60 - 1463 Wall unit W66xD37xH110 with two upper doors and one lower folding door with laundry basket

LAVARREDO - 4

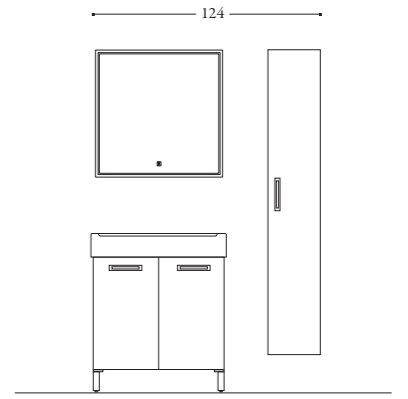

- IT 1275 Lavarredo monoblocco con piedini e due ante L75xP50xH87 completo di lavabo in ceramica. Con maniglie ad incasso - 1370RSD Specchio mod. Perimetro L70xH70 con sabbiatura perimetrale retroilluminata, touch e dimmer integrato - 1423 Colonna sospesa un'anta L29xP22xH169 con maniglia ad incasso
- ENG 1275 Lavarredo monobloc with feet and two doors W75xP50xH87 complete with ceramic washbasin. With recessed handles - 1370RSD Mirror mod. Perimetro W70xH70 with backlit perimeter sandblasting, touch and integrated dimmer - 1423 Suspended column one door W29xP22xH169 with recessed handle

LAVARREDO - 5



- IT 965 Lavarredo lavabo in ceramica L60xP50
- ENG 965 Lavarredo ceramic washbasin W60xD50

LAVARREDO - 6

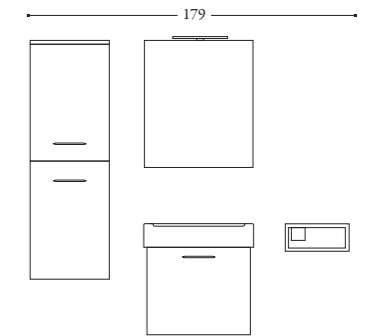

- IT 1665 Lavarredo monoblocco sospeso con cassettoni L60xP50xH62 completo di lavabo in ceramica. - 1360 Specchio a giorno mod. Easy L60xH70 - 718 Lampada mod. Luna L30cm - 1442 Colonna sospesa L44xP37xH132 con un'anta battente ed un'anta a ribalta con cesto porta biancheria - 3MLOTB35 Mensola multifunzione L35xP15xH15 con ripiano e bicchiere integrato in ocritech
- ENG 1665 Lavarredo suspended monobloc with drawer W60xD50xH62 complete with ceramic washbasin. - 1360 Open mirror mod. Easy W60xH70 - 718 Lamp mod. Luna L30cm - 1442 Suspended column W44xD37xH132 with one hinged door and one folding door with laundry basket - 3MLOTB35 Multifunctional shelf W35xD15xH15 with shelf and integrated glass in ocritech

1

Composizione
Composition

SKEMA



SKEMA

1:50

Bagno
7 m²

Camera
14 m²

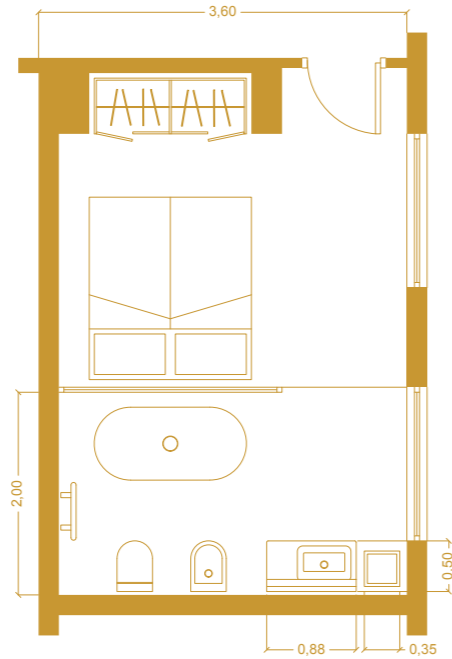

IT

Una struttura comprensibile e chiara. È quello che vediamo osservando Skema: una collezione dal taglio industrial che evoca atmosfere grunge. Perpendicolarità, linee rette che si incontrano, vuoti da riempire a propria discrezione, sono le regole dell'essenzialità.

Strutture lineari in alluminio declinate nei seducenti colori nero opaco, bronzo e oro satinati. Finiture pregiate che contribuiscono all'eleganza e allo stile. I lavabi in ceramica Nanco caratterizzati da bacini ampi e pratici, alti 20 cm.

Il senso della misura e l'estetica essenziale si esprimono anche nei cassetti a scomparsa, nei pensili e nelle colonne con ripiani in cui ordinare tutti gli oggetti per vivere il bagno.

Skema garantisce una personalità forte e decisa in qualsiasi ambiente.

ENG

An understandable and clear structure. This is what we see when looking at Skema: a collection with an industrial style that evokes grunge atmospheres. Perpendicularity, straight lines that meet each other, voids to be filled at one's discretion, these are the rules of essentiality. Linear aluminum structures declined in the seductive colors of matt black, satin bronze and gold. Fine finishes that contribute to elegance and style. Nanco ceramic washbasins are characterized by large and practical basins, 20 cm high. The sense of proportion and essential aesthetics are also expressed in the retractable drawers, wall units and columns with shelves in which to organize all the objects for living the bathroom.

Skema guarantees a strong and decisive personality in any environment.



2

Composizione
Compositon

SKEMA

3

Composizione
Composition

SKEMA





COLORI DISPONIBILI

COLORS AVAILABLE

TUNDRA Opaco Matt Lucido Glossy cod. 01TN cod. 02TN	CAPPUCCINO Opaco Matt Lucido Glossy cod. 01CU cod. 02CU	BIANCO Opaco Matt Lucido Glossy cod. 01BO cod. 02BO
ROSA HIMALAYA Opaco Matt Lucido Glossy cod. 01RH cod. 02RH	CORDA Opaco Matt Lucido Glossy cod. 01CD cod. 02CD	SALVIA Opaco Matt Lucido Glossy cod. 01SV cod. 02SV
BALTICO Opaco Matt Lucido Glossy cod. 01BT cod. 02BT	BURRO Opaco Matt Lucido Glossy cod. 01BR cod. 02BR	VERDE Opaco Matt Lucido Glossy cod. 01VE cod. 02VE
PRUGNA Opaco Matt Lucido Glossy cod. 01PR cod. 02PR	MENTA Opaco Matt Lucido Glossy cod. 01MN cod. 02MN	ZUCCA Opaco Matt Lucido Glossy cod. 01ZC cod. 02ZC
CIOCCOLATO Opaco Matt Lucido Glossy cod. 01CT cod. 02CT	SENAPE Opaco Matt Lucido Glossy cod. 01SN cod. 02SN	TURCHESE Opaco Matt Lucido Glossy cod. 01TR cod. 02TR
GRIGIO Opaco Matt Lucido Glossy cod. 01GR cod. 02GR	SABBIA Opaco Matt Lucido Glossy cod. 01SB cod. 02SB	
NERO Opaco Matt Lucido Glossy cod. 01NR cod. 02NR	ARANCIO Opaco Matt Lucido Glossy cod. 01AA cod. 02AA	
PIETRA Opaco Matt Lucido Glossy cod. 01PE cod. 02PE	CANAPA Opaco Matt Lucido Glossy cod. 01CN cod. 02CN	
AVIO Opaco Matt Lucido Glossy cod. 01AV cod. 02AV	ARGILLA Opaco Matt Lucido Glossy cod. 01FN cod. 02FN	

IT

Le strutture lineari di Skema sono disponibili sia con ripiani sia con delle cassettiere per riporre gli oggetti in uno spazio chiuso.

ENG

Skema linear columns are available both with shelves and with drawers for storing objects in a closed space.

	NERO SATINATO - BLACK MATT
	BRONZO - BRONZE
	ORO - GOLD

LEGNI MELAMINICI **MELAMINE WOODS**

BIANCO VERTICALE cod. VT	LARICE IRIS cod. IL	ROVERE ADAMELLO cod. AR	OLMO PERLA cod. PO	ROVERE ROSA cod. RR	ANTRACITE cod. AN
BASIC WHITE cod. BW	OLMO MONTANO cod. MO	QUERCIA BRUCIATO cod. BT	QUERCIA BIANCO cod. QB	CEMENTO cod. CT	

ESSENZA 4.0

ROVERE MORO cod. MR	OLMO GRIGIO cod. GO
-------------------------------	-------------------------------

LE NOSTRE PROPOSTE
OUR PROPOSALS

SKEMA - 1

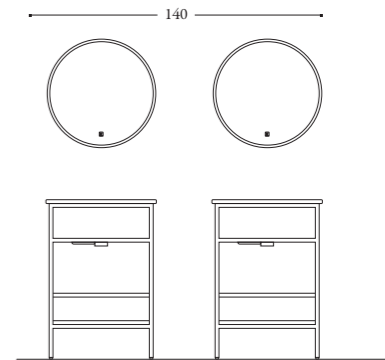

IT 365CN Skema monoblocco L60xP50xH88 con struttura in alluminio, lavabo in ceramica mod. Nanco e cassetto inferiore con apertura push and pull - 1214RSD Specchio tondo a giorno Ø60 con sabbiatura perimetrale retroilluminata, touch e dimmer integrato (x2)

ENG 365CN Skema monobloc W60xD50xH88 with aluminum structure, ceramic washbasin mod. Nanco and lower drawer with push and pull opening - 1214RSD Round open mirror Ø60 with backlit perimeter sandblasting, touch and integrated dimmer (x2)

SKEMA - 2

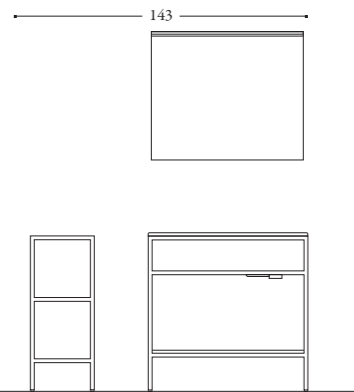

IT 395N Skema monoblocco L88xP50xH88 con struttura in alluminio, lavabo in ceramica mod. Nanco con bacino decentrato e ripiano inferiore - 3RM9070 Specchiera in alluminio Road L90xH70 con mensola integrata - 733 Lampada mod. Mirror L90 - 3CL3585 Skema base L35xP34xH85 con struttura in alluminio e tre ripiani in melaminico

ENG 395N Skema monobloc W88xD50xH88 with aluminum structure, ceramic washbasin mod. Nanco with decentralized basin and lower shelf - 3RM9070 Road aluminum mirror W90xH70 with integrated shelf - 733 Lamp mod. Mirror L90 - 3CL3585 Skema base W35xP34xH85 with aluminum structure and three melamine shelves

SKEMA - 3

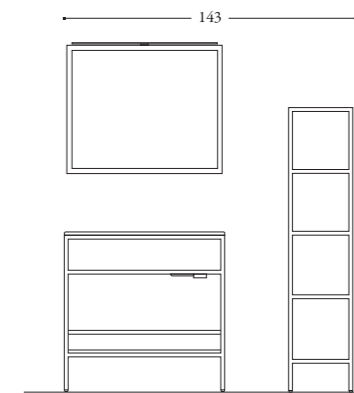

IT 395CN Skema monoblocco L88xP50xH88 con struttura in alluminio, lavabo in ceramica mod. Nanco con bacino decentrato e ripiano cassetto inferiore con apertura push and pull - 3C85 Specchio Skema con telaio L85xP70 - 7308 Lampada mod. Stealth L80cm - 3CL35155 Skema Colonna L35xP34xH155 con struttura in alluminio e cinque ripiani in melaminico

ENG 395CN Skema monobloc W88xD50xH88 with aluminum structure, ceramic washbasin mod. Nanco with decentralized basin and lower drawer shelf with push and pull opening - 3C85 Skema mirror with frame W85xP70 - 7308 Lamp mod. Stealth L80cm - 3CL35155 Skema Column W35xP34xH155 with aluminum structure and five melamine shelves

I C A R O

IT

Mara ha quasi finito di stendere lo smalto (colore rosa chiaro), le manca solo il mignolo sinistro. Domani ci sarà la riunione con il team prima della presentazione e dovrà essere impeccabile.

Dopo lo smalto sarà il turno della crema per il viso (con olio di argan e acido ialuronico), ora adagiata sulla mensola. Ed è in quel momento che perde il senso della misura e si pennella il dito... per rimuovere quella sbavatura ha bisogno di un cotton fioc! Appoggia lo smalto sul piano del lavabo in ceramica (colore bianco lucido) e apre il mobile (colore Olmo Perla) per prenderlo.

Et voilà! Cotton fioc preso, dito pulito, smalto intatto. È ora di completare l'opera.

ENG

Mara has almost finished applying the nail polish (light pink color), it only remains her left little finger. Tomorrow there will be the team meeting before the presentation and she will have to be impeccable. After the nail polish it will be the turn of the face cream (with argan oil and hyaluronic acid), now lying on the shelf. And it's at that moment that she loses her sense of proportion and brushes her finger... to remove that smudge she needs a cotton swab! She places the nail polish on the ceramic sink top (glossy white color) and opens the cabinet (Pearl Elm color) to take it.

Et voilà! Cotton swab taken, finger cleaned, nail polish intact. It's time to complete the work.

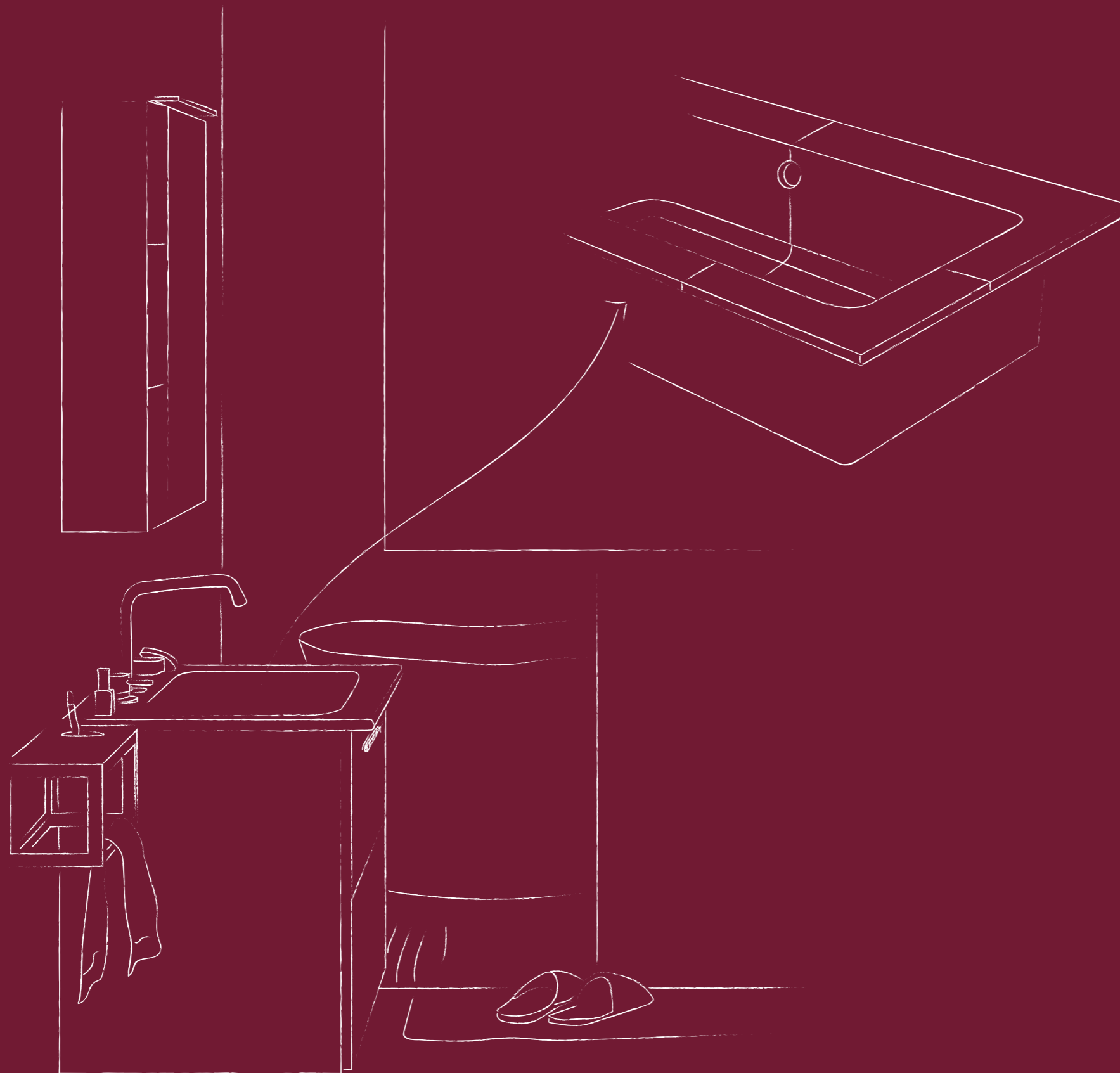



1

Composizione
Compositon

ICARO

ICARO

—
5 m² 1:50

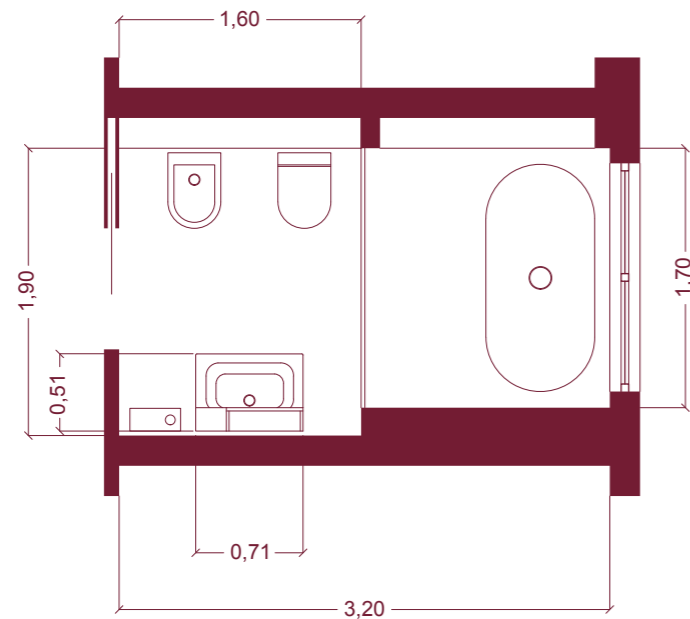

IT

Icaro rappresenta la quintessenza del bagno, caratterizzato da un'estetica minimale e pulita. Un mobile monoblocco costituito da cassetti ampi e grandi e da lavabi in ceramica che incontrano il gusto contemporaneo. Icaro è eleganza e armonia. La funzionalità si esprime nella versatilità di finiture e colori e nella capacità di adattarsi anche ai bagni più piccoli. Per dare vita a composizioni versatili e a bagni di tendenza

ENG

Icaro represents the quintessence of the bathroom, characterized by a minimal and clean aesthetic. A monobloc piece of furniture made up of large, spacious drawers and ceramic washbasins that meet contemporary taste. Icaro is elegance and harmony. Functionality is expressed in the versatility of finishes and colors and the ability to adapt to even the smaller bathrooms. To give life to versatile compositions and trendy bathrooms.



2

Composizione
Composition

ICARO



3

Composizione
Composition

ICARO



4

Composizione
Composition

ICARO





IT

Questo lavabo in ceramica è reso ancora più elegante dal bordo sottile, che ricopre l'intera superficie del mobile, ottenuto dopo un particolare processo di rettifica.

ENG

This ceramic washbasin is made even more elegant by the thin edge, which covers the entire surface of the furniture, obtained after a particular grinding process.

LEGNI MELAMINICI **MELAMINE WOODS**

BIANCO VERTICAL cod. VT	LARICE IRIS cod. IL
BASIC WHITE cod. BW	OLMO MONTANO cod. MO
ROVERE ADAMELLO cod. AR	OLMO PERLA cod. PO
QUERCIA BRUCIATO cod. BT	QUERCIA BIANCO cod. QB
ROVERE ROSA cod. RR	ANTRACITE cod. AN
CEMENTO cod. CT	
ESSENZA 4.0	
ROVERE MORO cod. MR	OLMO GRIGIO cod. GO

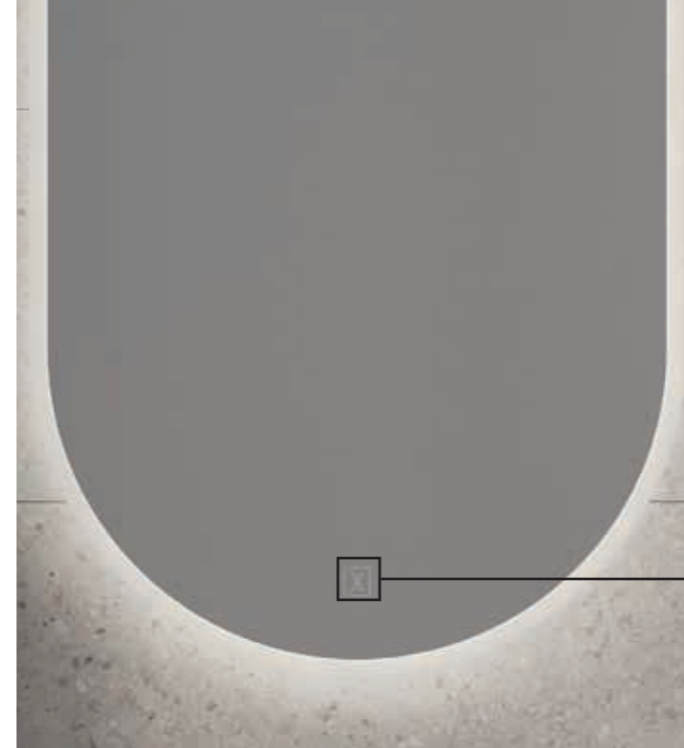

IT

Questa X contraddistingue i nostri specchi touch. È il pulsante con il quale impostare l'intensità e il calore della luce. I parametri si regolano facilmente con diversi tipi di pressione.

ENG

This X distinguishes our touch mirrors. It's the button with which to set the intensity and warmth of light. The parameters are easily adjusted with different types of pressure.

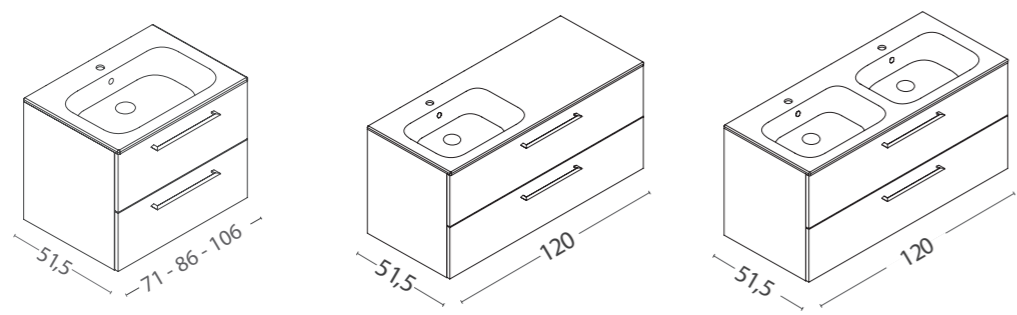

COLORI DISPONIBILI

COLORS AVAILABLE

TUNDRA Opaco Matt Lucido Glossy cod. 01TN cod. 02TN	CAPPUCCINO Opaco Matt Lucido Glossy cod. 01CU cod. 02CU	BIANCO Opaco Matt Lucido Glossy cod. 01BO cod. 02BO	ROSA HIMALAYA Opaco Matt Lucido Glossy cod. 01RH cod. 02RH	CORDA Opaco Matt Lucido Glossy cod. 01CD cod. 02CD
BALTICO Opaco Matt Lucido Glossy cod. 01BT cod. 02BT	BURRO Opaco Matt Lucido Glossy cod. 01BR cod. 02BR	SALVIA Opaco Matt Lucido Glossy cod. 01SV cod. 02SV	VERDE Opaco Matt Lucido Glossy cod. 01VE cod. 02VE	ZUCCA Opaco Matt Lucido Glossy cod. 01ZC cod. 02ZC
PRUGNA Opaco Matt Lucido Glossy cod. 01PR cod. 02PR	MENTA Opaco Matt Lucido Glossy cod. 01MN cod. 02MN	TURCHESE Opaco Matt Lucido Glossy cod. 01TR cod. 02TR	CIOCCOLATO Opaco Matt Lucido Glossy cod. 01CT cod. 02CT	SENAPE Opaco Matt Lucido Glossy cod. 01SN cod. 02SN
GRIGIO Opaco Matt Lucido Glossy cod. 01GR cod. 02GR	SABBIA Opaco Matt Lucido Glossy cod. 01SB cod. 02SB	ARANCIO Opaco Matt Lucido Glossy cod. 01AA cod. 02AA	CANAPA Opaco Matt Lucido Glossy cod. 01CN cod. 02CN	PIETRA Opaco Matt Lucido Glossy cod. 01PE cod. 02PE
NERO Opaco Matt Lucido Glossy cod. 01NR cod. 02NR	AVIO Opaco Matt Lucido Glossy cod. 01AV cod. 02AV	ARGILLA Opaco Matt Lucido Glossy cod. 01FN cod. 02FN		

LE NOSTRE PROPOSTE

OUR PROPOSALS

ICARO - 1

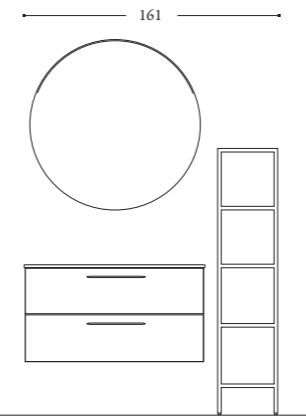

- IT **000106** Icaro monoblocco sospeso due cassetti L106xP51xH57 completo di lavabo in ceramica - **1213CM** Specchio diametro Ø80 con cornice in metallo ed illuminazione integrata - **3CL35155** Skema Colonna L35xP34xH155 con struttura in alluminio e cinque ripiani in melaminico (x2)
- ENG **000106** Icaro suspended monobloc with two drawers W106xD51xH57 complete with ceramic washbasin **1213CM** Mirror diameter Ø80 with metal frame and integrated lighting - **3CL35155** Skema Column W35xP34xH155 with aluminum structure and five melamine shelves (x2)

ICARO - 2

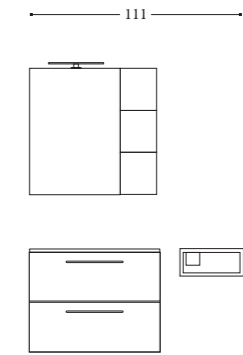

- IT **00075** Icaro monoblocco sospeso due cassetti L71xP51xH57 completo di lavabo in ceramica - **3MLOTB35** Mensola multifunzione L35xP15xH15 con ripiano e bicchiere integrato in ocritech - **229551** Specchio pensile contenitore 1 anta L50xP15xH70 - **3CM2015** Contenitore in metallo reversibile L20xP15xH70 - **718** Lampada mod. Luna L30cm
- ENG **00075** Icaro suspended monobloc with two drawers W71xD51xH57 complete with ceramic washbasin - **3MLOTB35** Multifunctional shelf W35xD15xH15 with shelf and integrated glass in ocritech - **229551** Hanging container mirror 1 door W50xP15xH70 - **3CM2015** Reversible metal container W20xD15xH70 - **718** Lamp mod. Luna L30cm

ICARO - 3

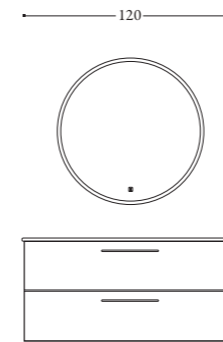

- IT **000B120** Icaro monoblocco sospeso due cassetti L120xP51xH56 completo di lavabo in ceramica bivasca - **1215RSD** Specchio Ø100 reversibile sabbiatura perimetrale retroilluminata, touch e dimmer integrato
- ENG **000B120** Icaro suspended monobloc with two drawers W120xD51xH56 complete with ceramic double basin washbasin - **1215RSD** Reversible mirror Ø100, backlit perimeter sandblasting, touch and integrated dimmer

ICARO - 4

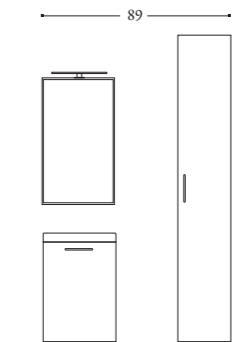

- IT **00143** Icaro Smart monoblocco sospeso 1 anta L40XP35XH60 completo di lavabo in ceramica - **1340** Specchio a giorno Easy L40xH70 - **718** Lampada mod. Luna L30cm - **1423** Colonna sospesa un'anta L29xP22xH169
- ENG **00143** Icaro Smart suspended monobloc 1 door W40XP35XH60 complete with ceramic washbasin - **1340** Open mirror Easy W40xH70 - **718** Lamp mod. Luna L30cm - **1423** Suspended column one door W29xP22xH169

ICARO - 5

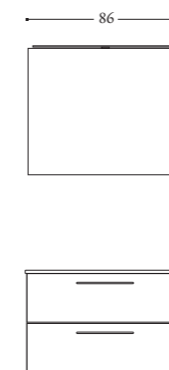

- IT **00095** Icaro monoblocco sospeso 2 cassetti L86XP51XH57 completo di lavabo in ceramica - **1385** Specchio a giorno Easy L85xH70 - **7308** Lampada mod. Stealth L80
- ENG **00095** Icaro suspended monobloc 2 drawers W86XP51XH57 complete with ceramic washbasin - **1385** Open mirror Easy W85xH70 - **7308** Lamp mod. Stealth L80

CONCLUSIONE

IL NOSTRO BAGNO, LA VOSTRA STORIA

OUR BATHROOM, YOUR STORY

IT

Nel viaggio attraverso le pagine di questo catalogo, avete scoperto una concezione di design e di funzionalità che va oltre il semplice arredamento del bagno.

Ogni funzione è la risposta a un bisogno quotidiano, si interfaccia con i momenti della nostra vita.

Questo Manuale del bagno funzionale nasce non solo per mostrarvi i nostri prodotti, ma anche per condurvi nel nostro immaginario: per ispirarvi e raccontarvi le nostre idee. È un invito a vivere il bagno come un capitolo prezioso della vostra giornata, perché crediamo che ogni bagno racconti una storia.

La prossima è la vostra.

ENG

On the journey through the pages of this catalogue, you have discovered a concept of design and functionality that goes beyond simple bathroom furnishings. Each function is the answer to a daily need, it interfaces with the moments of our life. This Functional bathroom manual is born not only to show you our products, but also to lead you into our imagination: to inspire you and tell you about our ideas. It's an invitation to live the bathroom as a precious chapter of your day, because we believe that every bathroom tells a story.

The next one is yours.



IT

Dati tecnici, foto, colori e descrizioni sono puramente indicativi di una produzione in serie, per cui Xilon si riserva il diritto di apportare modifiche e/o aggiornamenti ai propri prodotti e ai propri listini in qualsiasi momento senza alcun obbligo di preavviso, a suo insindacabile giudizio, tali da non inficiare le caratteristiche standard del prodotto mostrato, che pur risultando eventualmente diverso nella presentazione, rispetterà ugualmente la sua natura funzionale.

ENG

Technical data, photos, colors and descriptions are purely indicative of a standard production. Xilon reserves the right to make changes and/or updates to the products and the price lists at any time and without prior notice, at its own discretion, such as not to jeopardize the standard features of the displayed products. The products, while eventually resulting in different presentation, still will respect their functional destination. This catalog cancels and replaces all previous versions.

Catalog creation:
Robin network srls

Art Director: Giulia Carabelli, Irene Celani
Copywriter: Danilo Mecucci
Graphic designer: Giulia Carabelli
Rendering designer: Irene Celani

Print: Sincromia srl

Print date: December 2023

XILON srl - Via Flaminia Km. 58,200
Civita Castellana (VT)
info@xilon.it
+39 0761 540197
+39 0761 542055

www.xilon.it

